

## Antipánico

*Security rim locks - Cerraduras de alta seguridad de sobreponer - Накладные замки высокой степени защиты*





**ATTESTATO DI CONFORMITÀ**  
DIRETTIVA 89/106/CEE  
**CERTIFICATE OF CONFORMITY**  
DIRECTIVE 89/106/CEE



Questo certificato è rilasciato in conformità a quanto prescritto dall'Art.6 par.2 lettera b) del DPR 21 aprile 1993, n°246 (Direttiva 89/106/CEE) ed attesta la conformità del prodotto di seguito identificato agli Art.1, Art.2 ed allegato A del DPR 21 aprile 1993, n°246 (Direttiva 89/106/CEE)

*This certificate has been issued in conformity to what prescribed by the Art.6 par.2 letter b) of the DPR 21/04/1993, n°246 (Directive 89/106/EC) and certifies the conformity of the product described below to the Art.1, Art.2 and attachment A of DPR 21/04/1993, n°246 (Directive 89/106/EC)*

<b>ATTESTATO N°</b>	<b>807 - CPD - 2005</b>	<b>CERTIFICATE N°</b>
<b>Organismo notificato</b>		<b>Notified Body</b>
ICIM S.p.A. - Piazza Don E. Mapelli, 75 – 20099 Sesto San Giovanni (ITALY)		N° d'identification: 0425
<b>Dati Fabbricante</b>		<b>Manufacturer</b>
Sede legale	ANTIPANIC S.r.l. Via Marconi, 126 - Casalecchio di Reno (BO)	Head office
Unità operativa		Operative unit
<b>Dati prodotto</b>		<b>Product</b>
Tipologia	DISPOSITIVI ANTIPANICO PER USCITE DI SICUREZZA AZIONATI MEDIANTE UNA BARRA ORIZZONTALE <b>PANIC EXIT DEVICES</b>	Type
Denominazione	Serie: "MODULODUE" Codici: 200/70, 200/80, 401, 402, 403, 401/x, 402/x, 403/x 200/70/MC1, 200/70/MC2, 200/70/MC1+2, 200/80/MC1, 200/80/MC2, 200/80/MC1+2, 401/MC1, 401/MC2, 401/MC1+2, 401/x/MC1, 401/x/MC2, 401/x/MC1+2, 402/MC1, 402/MC2, 402/MC1+2, 402/x/MC1, 402/x/MC2, 402/x/MC1+2, 403/MC1, 403/MC2, 403/MC1+2, 403/x/MC1, 403/x/MC2, 403/x/MC1+2 Accessori: 1100/y/z, 450, 455, 450/x, 455/x  I codici di cui sopra possono essere venduti come personalizzati per vari clienti. Nello specifico, le sigle che potrebbero comparire all'interno dei codici sono i seguenti: IVA – corrispondente al cliente IVANA CLE – corrispondente al cliente FAMASSER per linea CLEDOR BTA – corrispondente al cliente BRAVOTEAM per linea BRAVOTECK  Cod. Prefer: SIN401.YYY.000, SIN402.YYY.000, SIN403.YYY.000, Accessori: SIN110.ZYY.000, SIN450.ZYY.000, SIN455.ZYY.000 Con Y variabile di finitura – Z variabile dimensionale Cod. Justor: A-7010.09, A7010.0x, A-7010.1x, A-7020.09, A-7020.0x, A-7020.1x, A-7030.09, A-7030.0x, A-7030.1x. Accessori: A-7110.0x, A-7110.1x, A-7115.0x, A-7115.1x, A712y.0x, A-712y.1x	Denomination
Sistema di attestazione della conformità	1	Attestation of conformity
Norma di riferimento	EN 1125:2008	Standard
Classificazione	3   7   7   B   1   4   2   2   A   A	Classification
<b>Eventuali estensioni</b>	Nessuna / None	<b>Extensions</b>
<b>Eventuali condizioni di subordinazione della Certificazione CE</b>	Nessuna / None	<b>Possible conditions of subordination of the CE Certification</b>

**Il presente attestato è valido esclusivamente per il prodotto indicato. Eventuali varianti da apportare devono essere approvate da ICIM SpA**  
*The present issue is valid only for the product described above. Possible changes to be brought in have to be approved by ICIM S.p.A*

Data di emissione  
First issue  
**28/07/2005**

Emissione corrente  
Current Issue  
**01/03/2010**

Data di scadenza  
Expiring date  
**27/07/2015**

  
ICIM S.p.A.  
Il Presidente  
Ing. Tullio Badino



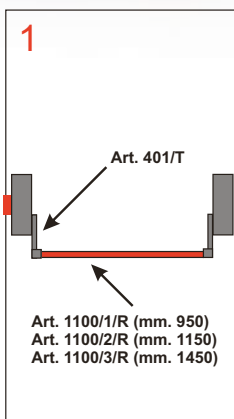

Cilindro e maniglia esterna Art. 1090

Cilindro e pomolo esterno Art. 1090P

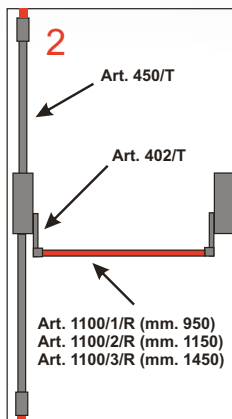

Cilindro e maniglia esterna Art. 1090

Cilindro e pomolo esterno Art. 1090P

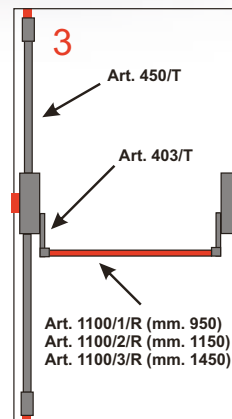

Cilindro e maniglia esterna Art. 1090

Cilindro e pomolo esterno Art. 1090P

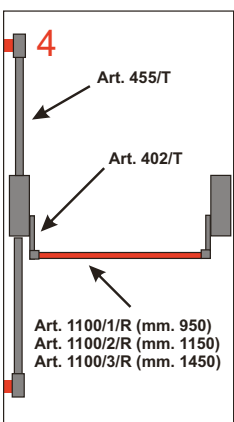

Cilindro e maniglia esterna Art. 1090

Cilindro e pomolo esterno Art. 1090P

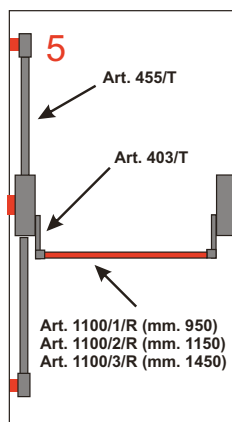

Cilindro e maniglia esterna Art. 1090

Cilindro e pomolo esterno Art. 1090P

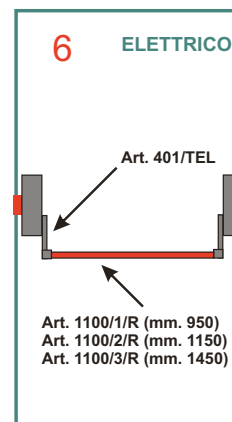

Cilindro e maniglia esterna Art. 1092

Cilindro e pomolo esterno Art. 1092P

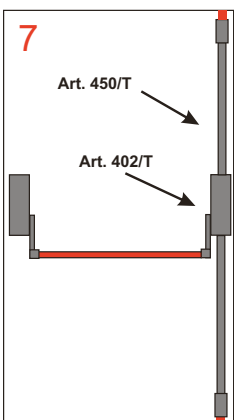

Cilindro e maniglia esterna Art. 1090

Cilindro e pomolo esterno Art. 1090P

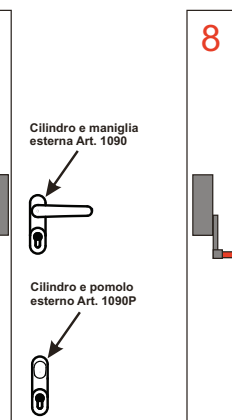

Cilindro e maniglia esterna Art. 1090

Cilindro e pomolo esterno Art. 1090P

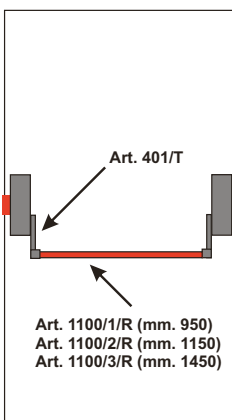

Cilindro e maniglia esterna Art. 1090

Cilindro e pomolo esterno Art. 1090P

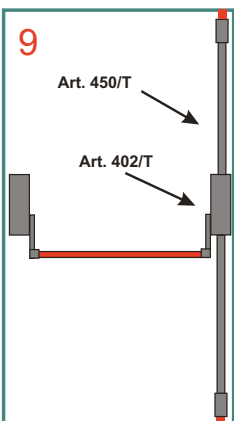

**ELETTRICO  
2 ANTE**

Cilindro e maniglia esterna Art. 1092

Cilindro e pomolo esterno Art. 1092P

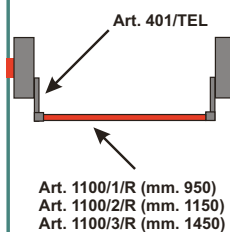

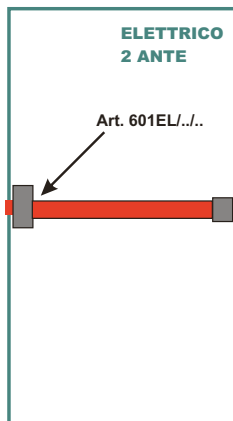
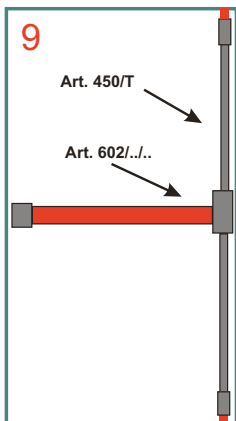
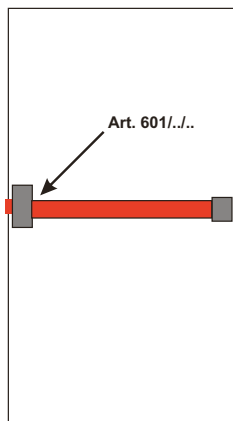
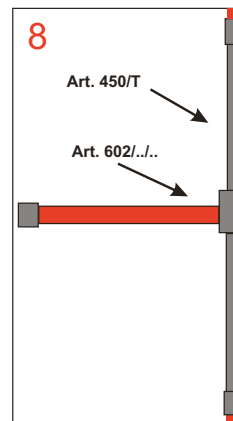
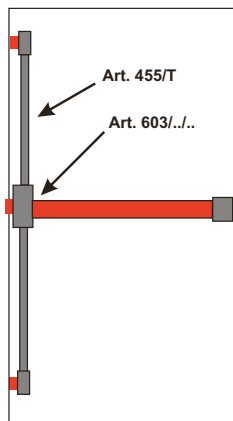
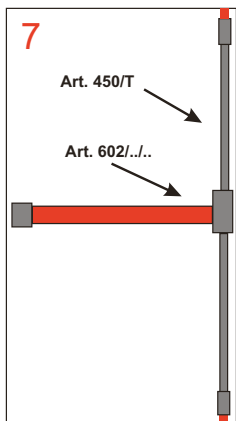
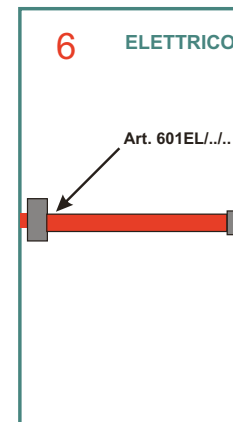
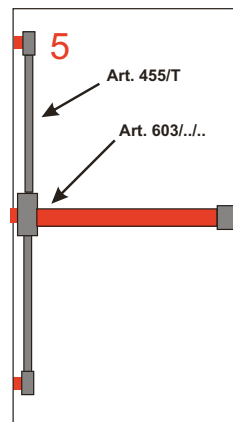
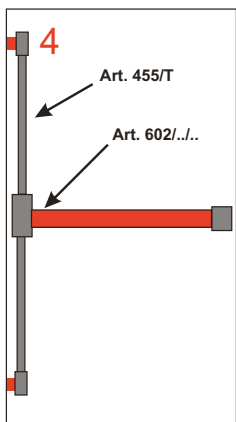
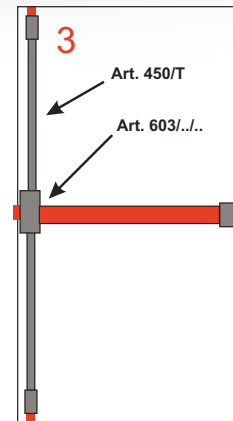
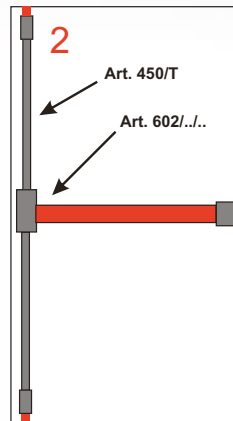
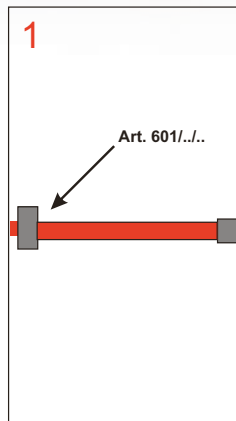



Il solidissimo blocco del braccetto elimina ogni possibile vibrazione o gioco della barra

## PUSH BAR

### REVERSIBILE COMPONIBILE

Perfettamente intercambiabile  
con altri tipi da montante

Scrocco in acciaio  
Cuffie in acciaio verniciato



### REVERSIBLE MODULAR

Steel latch bolts  
Black painted steel covers

Perfectly interchangeable  
with other kind of  
door style panic device



### RÉVERSIBLE MODULAIRE

Pênes dormants en acier  
Caches en acier laqué noir

Parfaitement interchangeable  
avec autres types de  
ouverture antipanique  
pour montant

confezione - boxing : 1 pz.

imballo - packing: 8 pz.

Cod. Art.	Colore - Colour	Descrizione - Description	
A401/T	Nero - Black - Noir RAL 9005	 <p>1 punto di chiusura 1 locking point 1 point de fermeture</p>	
A401/TG	Grigio - Grey - Gris RAL 7040 o RAL 9006 Aggiungere /G6 al codice		
A401/TB	Bianco - White - Blanc RAL 9010		
A401/TA	Verniciatura effetto acciaio Steel finish special painting Laquage spécial finition acier		
A402/T	Nero - Black - Noir RAL 9005	 <p>2 punti di chiusura 2 locking points 2 points de fermeture</p>	
A402/TG	Grigio - Grey - Gris RAL 7040 o RAL 9006 Aggiungere /G6 al codice		
A402/TB	Bianco - White - Blanc RAL 9010		
A402/TA	Verniciatura effetto acciaio Steel finish special painting Laquage spécial finition acier		
A403/T	Nero - Black - Noir RAL 9005	 <p>componibile 3 punti di chiusura modular 3 locking points modulaire 3 points de fermeture</p>	<p>disponibile anche con FERMO A GIORNO Aggiungere FG al codice available with DOGGING MECHANISM. Add FG code to the part number Disponible avec MÉCANISME DE DOGGING. Ajouter le code FG</p>
A403/TG	Grigio - Grey - Gris RAL 7040		
A403/TG6	Grigio RAL 9006		
A403/TB	Bianco - White - Blanc RAL 9010		
A403/TA	Verniciatura effetto acciaio Steel finish special painting Laquage spécial finition acier		
A403/TX	Cromo satinato Satiny chrome Chrome satinée		

Finitura a richiesta - Finition on request - Finition on demande:

O = Ottonato - Brass finished - Finition laiton



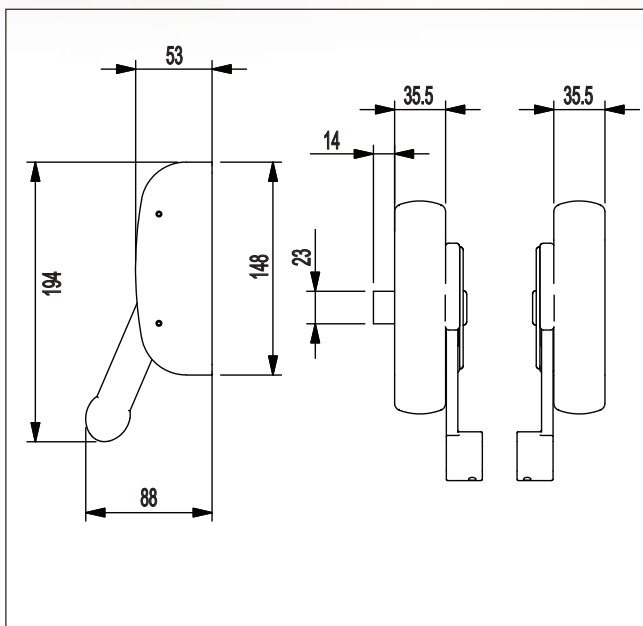

verniciatura speciale "effetto acciaio" vedi tabella pag. 50  
 "steel finish" special painting see page 50  
 laquage spécial "finition acier" voir page 50

cromo satinato vedi tabella pag. 50  
 satiny chrome see page 50  
 chrome satinée voir page 50



disponibili anche in versione con MICROSWITCH  
 vedere a pag. 61  
 available with MICROSWITCH see page 61  
 disponible avec MICROSWITCH voir page 61

#### Specifiche di capitolato

Maniglione antipanico "modulo-tondo Serie 400"

Maniglione antipanico da montante, reversibile e componibile a 1-2 e 3 punti di chiusura.

La reversibilità deve essere ottenuta tramite un solido blocco esterno senza alcuna interferenza con il meccanismo interno.

Classificazione secondo la  
 NUOVA Norma EN 1125:2008

3 - 7 - 7 - B - 1 - 4 - 2 - 2 - A - A



# modulo-elettrico



## REVERSIBILE

Perfettamente intercambiabile con altri tipi da montante

Scrocchi in acciaio  
Cuffie in acciaio verniciato  
12 V. AC-DC - 1 A.

## REVERSIBLE

Steel latch bolts  
Black painted steel covers  
12 V. AC-DC - 1 A.

Perfectly interchangeable with other kind of door style panic device

## RÉVERSIBLE

Pênes dormants en acier  
Caches en acier laqué noir  
12 V. AC-DC - 1 A.

Parfaitement interchangeable avec autres types de ouverture antipanique pour montant

confezione - boxing : 1 pz.

imballo - packing: 8 pz.

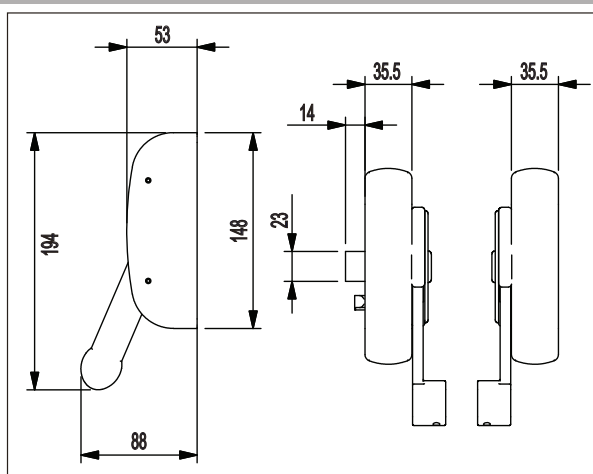

Cod. Art.	Colore - Colour	Descrizione - Description
A401/TEL	Nero - Black - Noir RAL 9005	1 punto di chiusura 1 locking point 1 point de fermeture  con FERMO A GIORNO with DOGGING MECHANISM avec MÉCANISME DE DOGGING
A401/TEL/G	Grigio - Grey - Gris RAL 7040	
A401/TEL/G6	Grigio RAL 9006	
A401/TEL/B	Bianco - White - Blanc RAL 9010	
A401/TEL/A	Verniciatura effetto acciaio Steel finish special painting Laquage spécial finition acier	
A401/TEL/X	Cromo satinato Satiny chrome Chrome satinée	

Finitura a richiesta - Finition on request - Finition on demande:  
O = Ottonato - Brass finished - Finition laiton

### Specifiche di capitolato

Maniglione antipanico elettrico a 12 V. "modulo-tondo Serie 400"

Maniglione antipanico da montante, reversibile a 1 punto di chiusura. La reversibilità deve essere ottenuta tramite un solido blocco esterno senza alcuna interferenza con il meccanismo interno.

Classificazione secondo la  
NUOVA Norma EN 1125:2008

3 - 7 - 7 - 0 - 1 - 4 - 2 - 2 - A - A



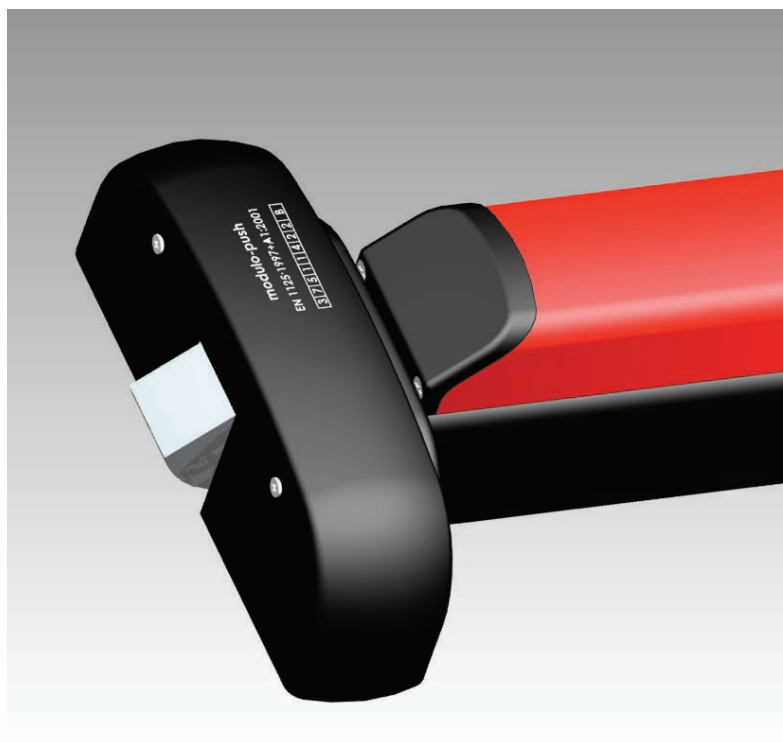

## TOUCH BAR

### REVERSIBILE COMPONIBILE

Scrocchi in acciaio  
Cuffie in acciaio verniciato  
Carter e barra in alluminio











### TOUCH-BAR REVERSIBLE - MODULAR

Steel latch bolts  
Black painted steel covers

### TOUCH-BAR MODULAIRE

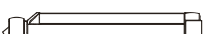
Pênes dormants en acier  
Caches en acier laqué noir

confezione - boxing : 1 pz.

Cod. Art.	Lunghezza Lenght	Descrizione Description	Colori - Colours	
			Cod.	Colori - Colours
A601/1/...	840	1 punto di chiusura 1 locking point 1 point de fermeture	<b>Cod. NR</b>	 Nero/rosso - Black/red - Noire/rouge RAL 9005/3020
A601/2/...	1170		<b>Cod. NV</b>	 Nero/verde - Black/green - Noire/vert RAL 9005/6029
A601/3/...	1300		<b>Cod. NN</b>	 Nero/nero - Black/black - Noire/noire RAL 9005/9005
A602/1/...	840	2 punti di chiusura 2 locking points 2 point de fermeture	<b>Cod. GG</b>	 Grigio/grigio - Grey/Grey - Gris/Gris RAL 7040/7040 oppure - or -ou
A602/2/...	1170		<b>Cod. GG6</b>	Grigio/grigio RAL 9006/9006
A602/3/...	1300		<b>Cod. BB</b>	 Bianco/bianco - White/White - Blanc/Blanc RAL 9010/9010
A603/1/...	840	3 punti di chiusura 3 locking points 3 point de fermeture	<b>Cod. NS</b>	 Nero/Silver - Black/Silver - Noire/argent RAL 9005/all. anodizzato - anodized alum.
A603/2/...	1170		<b>Cod. AA</b>	 Effetto acciaio - steel finish special painting Laquage spécial finition acier
A603/3/...	1300		<b>Cod. XX</b>	 Cromo satinato - Satiny chrome Chrome satinée Solo per - only for - seulement pour Art. 603/2/XX(mm. 1170) e Art. 603/3/XX (mm. 1300)

Classificazione secondo la  
NUOVA Norma EN 1125:2008

**3 - 7 - 7 - B - 1 - 4 - 2 - 2 - B - A**

disponibile anche con FERMO A GIORNO.  
Aggiungere FG al codice  
available with DOGGING MECHANISM.  
Add FG code to the part number  
Disponible avec MÉCANISME DE DOGGING.  
Ajouter le code FG

Finitura a richiesta - Finition on request - Finition on demande:  
O = Ottonato - Brass finisced - Finition laiton  
Solo per - only for - seulement pour:  
Art. 603/2/OO(mm. 1170) e Art. 603/3/OO (mm. 1300)

**Specifiche di capitolato**

Maniglione antipatico "modulo-push bar Serie 600"  
Maniglione antipatico, reversibile a 1-2 e 3 punti di chiusura. Con meccanismo interno a cremagliera.



**Nero-Rosso**



**Nero-Verde**



**Nero-Nero**



**Grigio-Grigio**



**Bianco-Bianco**



**Nero-Silver**



Cod. Art.	Lunghezza Lenght	Descrizione - Description
A603/1/AA	840	3 punti di chiusura 3 locking point 3 point de fermeture  Effetto acciaio Steel finish special painting Laquage spécial finition acier
A603/2/AA	1170	
A603/3/AA	1300	
Cod. Art.	Lunghezza Lenght	Descrizione - Description
A603/2/XX	1170	3 punti di chiusura 3 locking point 3 point de fermeture
A603/3/XX	1300	Cromo satinato - Satiny chrome Chrome satinée

**Acciaio-Acciaio**

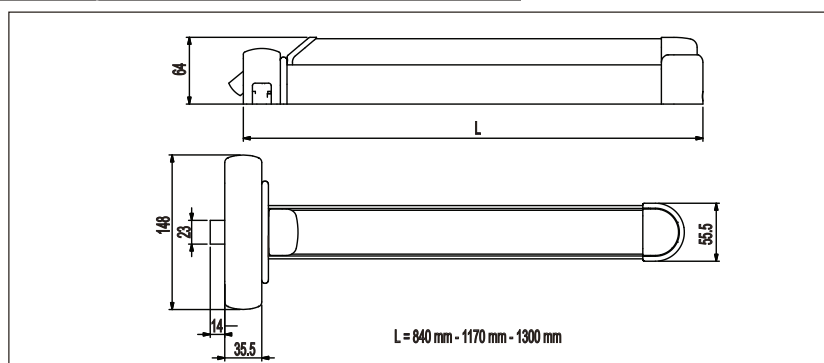

## TOUCH BAR ELETTRICO



### IL PRIMO TOUCH BAR ELETTRICO

#### Reversibile 1 punto di chiusura

Scrocchi in acciaio  
Cuffie in acciaio verniciato  
Carter e barra in alluminio  
12 V. AC-DC - 1 A.

### ELECTRIC TOUCH BAR

#### Reversible 1 locking point

Steel latch bolts  
Black painted steel covers  
12 V. AC-DC - 1 A.

### TOUCH BAR ELECTRIQUE

#### Réversible 1 point de fermeture

Pênes dormants en acier  
Caches en acier laqué noir  
12 V. AC-DC - 1 A.

confezione - boxing : 1 pz.

Cod. Art.	Lunghezza Lenght	Descrizione - Description
A601EL/1/...	840	1 punto di chiusura 1 locking point 1 point de fermeture
A601EL/2/...	1170	con FERMO A GIORNO with DOGGING MECHANISM avec MÉCANISME DE DOGGING
A601EL/3/...	1300	

Classificazione secondo la  
NUOVA Norma EN 1125:2008

3 - 7 - 7 - 0 - 1 - 4 - 2 - 2 - B - A



### Colori - Colours

- Cod. NR** Nero/rosso - Black/red - Noire/rouge  
RAL 9005/3020
- Cod. NV** Nero/verde - Black/green - Noire/vert  
RAL 9005/6029
- Cod. NN** Nero/nero - Black/black - Noire/noire  
RAL 9005/9005
- Cod. GG** Grigio/grigio - Grey/Grey - Gris/Gris  
RAL 7040/7040 oppure - or -ou
- Cod. GG6** Grigio/grigio RAL 9006/9006
- Cod. BB** Bianco/bianco - White/White - Blanc/Blanc  
RAL 9010/9010
- Cod. NS** Nero/argento - Black/Silver - Noire/argent  
RAL 9005/all. anodizzato - anodized alum.
- Cod. AA** Effetto acciaio - steel finish special painting  
Laquage spécial finition acier
- Cod. XX** Cromo satinato - Satiny chrome - Chrome satinée  
Solo per - only for - seulement pour  
art. 601EL/2/XX (mm. 1170) e 601EL/3/XX (mm. 1300)

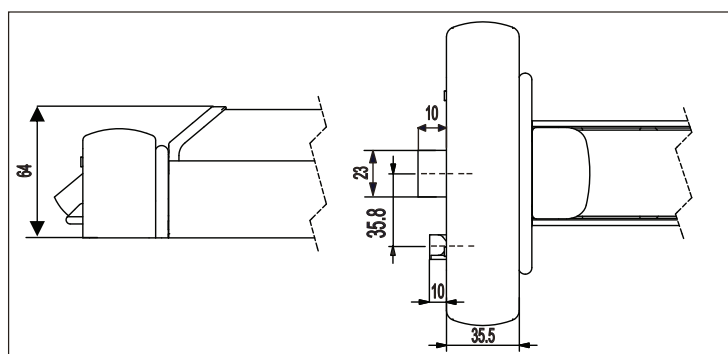

### Specifiche di capitolato

Maniglione antipanico elettrico a 12 V. "modulo-push bar Serie 600"

Maniglione antipanico, reversibile a 1 punto di chiusura.  
Con meccanismo interno a cremagliera.

### Finitura a richiesta - Finition on request - Finition on demande:

O = Ottonato - Brass finisced - Finition laiton

Solo per - only for - seulement pour:

Art. 601EL/2/OO (mm. 1170) e Art. 601EL/3/OO (mm. 1300)



# Maniglione antipanico con serratura



Push Panic device with lock

**A101**

**ti difende dalle effrazioni**

## ANTIPANICO DI SICUREZZA A 1 PUNTO DI CHIUSURA

Perfettamente intercambiabile con altri tipi preesistenti

Frontale inox piatto e U  
Entrate 25 - 30 e 35 mm.  
Catenacci, scrocco e quadro maniglia in acciaio  
Reversibile

## 1 LOCKING POINT SECURITY PANIC EXIT DEVICE

S/S flat and U-shaped front plate  
Backset 25 - 30 and 35 mm.  
Steel dead bolts, latch bolt and handle hub  
Reversible

## SERRURE ANTIPANIQUE DE SÉCURITÉ À 1 POINT DE FERMETURE

Têtière plate et U en acier inox  
Axe 25 - 30 et 35 mm.  
Pênes dormants, demi-tour et carré de poignée en acier  
Réversible

confezione - boxing : 1 pz.

Cod. Art.	Frontale Front plate 24 mm.	E	A	B
A101U/25T		25	40	34
A101U/30T		30	45	39
A101U/35T		35	50	44
A101PT/25T		25	40	37
A101PT/30T		30	45	42
A101PT/35T		35	50	47

Colori - Colour	
Nero - Black - Noir RAL 9005	
Bianco - White - Blanc RAL 9010	Aggiungere /B al codice Add /B code to the part number Ajouter le code /B
Grigio - Grey - Gris RAL 7040	Aggiungere /G al codice Add /G code to the part number Ajouter le code /G
Grigio RAL 9006	Aggiungere /G6 al codice Add /G6 code to the part number Ajouter le code /G6
Effetto acciaio - Steel finish special finition - Laquage spécial finition acier	Aggiungere /A al codice Add /A code to the part number Ajouter le code /A
Cromo satinato - Satiny chrome Cromé satiné	Aggiungere /TX al codice Add /TX code to the part number Ajouter le code /TX



Classificazione secondo la  
NUOVA Norma EN 1125:2008

**3 - 7 - 6 - 0 - 1 - 4 - 2 - 1 - A - B**

### Specifiche di capitolato

Maniglione antipanico "di-più Serie A101"

Maniglione antipanico inseribile all'interno di un profilato e dotato di 1 punto di chiusura a catenaccio basculante. Il collegamento tra la serratura interna ed il meccanismo esterno è costituito da uno speciale dispositivo a duplice funzione ambidestro già predisposto a ricevere sia il comando antipanico che la maniglia esterna di servizio (senza alcun intervento dell'applicatore). Dimensioni massime consentite della serratura interna mm. 170x50x19

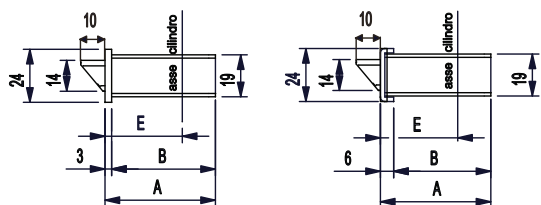
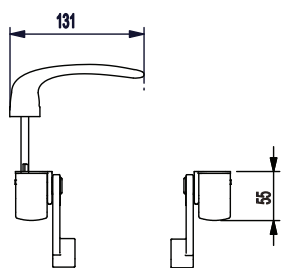
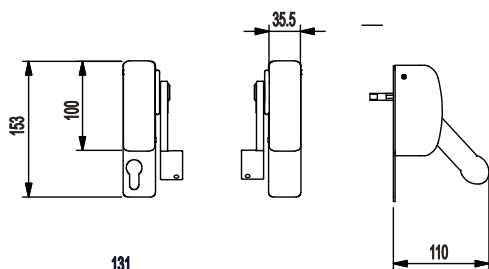
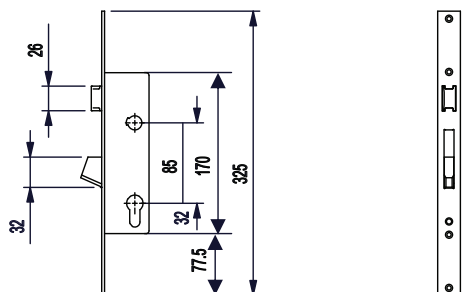

solo porte 1 anta  
only for one-wing doors  
uniquement sur portes à un vantail

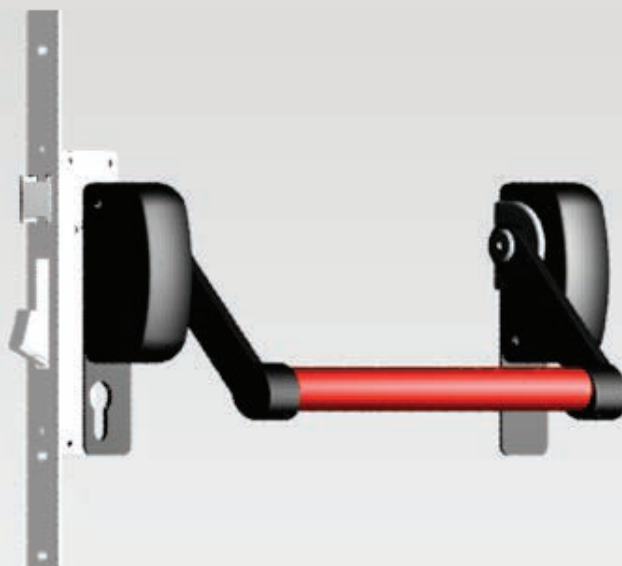

disponibile anche nei colori:

- bianco
- grigio
- effetto acciaio
- cromo satinato

finishing upon request

- white
- grey
- steel finish
- satiny chrome

finition sur demande

- blanc
- gris
- finition acier
- cromé satiné

Patented



## incontri specifici-striker for-gâche pour “ A101 ”

Cod. Art.	Profilo - Profile
A1001/1	<b>Agnelli Metalli</b> Esedra GA 53 complanare - Esedra T.T. 63 - Esedra T.T. 75 - <b>Alcan</b> Cristal - Green Keeper 53-60 - <b>Aliplast</b> 50 T.T. - <b>All.co</b> All.co K 40 - Export 40/50 - export 50 T.T. - <b>Alu-mec</b> Synthesis <b>Allumafel</b> Forma serie 31025 - <b>Alusuisse</b> Alsec 2000 - finestra -59 - <b>Anodil</b> Arkial serie Bx - <b>A.ser</b> Riviera serie rinforzata - <b>Bodega</b> Bga 50 - <b>Cortizo</b> Sistema cortizo 60 - <b>Equipe</b> Emal 40w - <b>Ekonal</b> I 70 apertura esterna - <b>Exlabesa</b> Platino puerta pr-7200 - <b>Garcia padrones aluminios s.l.</b> A 93 - <b>Gruppo extrugal</b> 40x40 R.p. 68 -p 45 - R.p. 52 puerta - <b>Hydro alluminio</b> Domal stopper pg - Domal break Pa 52 e 70 <b>Inasa reynold</b> 6040 - 7050 Rt - <b>Indinvest</b> Gold 400 - Gold 500 - <b>Inespal</b> Afill T.T. - Alfil - <b>Kawneer</b> System 1423 - System 1473 - <b>K.L. Aluminio s.a.</b> B.w. 50/52 - B.w. R. 57 - <b>Laminex</b> Star st 15/17 Euro star 9010 - <b>La semilavorati</b> Lido system complanare - <b>Metra</b> Nc 68 superthermic - <b>Morelli</b> Ma 8300 Ma 9500 - <b>Ocma</b> Fc 47 - Fc 55 - Fc 70 hercules - <b>Passerini</b> Ekip thermo sormonto - Ekip base <b>Perfival</b> V/94 - <b>Profils systemes</b> Serie 13 - <b>Provedora de aluminio s.a</b> Optima 1992 - <b>R.c. System</b> Performance 51 - <b>Reynaers</b> Thermo system 50/57 - Parallel system 50 - <b>Sunparadise</b> Fiesta 42 Thermo 60 - <b>Technal</b> Pbi - Pxi apertura esterna - Pbi new - <b>Trafileria emiliane</b> Eku 64 T.T. - <b>Van Beveren</b> Serie R 50 e Bb 50 - <b>Wicona</b> Serie 70000 - L/50 apertura esterna
A1001/2	<b>Alcan</b> Green porta 1 anta - Green porta 1 anta con riporto - Open porta 1 anta - Open porta 1 anta con riporto - <b>Alcoa</b> Alublind - <b>All.co</b> All.co 5 porta - All.co 5 T.T. Porta - Sicurblind porta - <b>Alumafel</b> Forma serie 31020 - <b>Alusuisse</b> Alsec 2000 59 porta Alsec 2000 69 porta - <b>Exlabesa</b> 3000 puerta - <b>Fwb brokelmann aluminium</b> serie TF porta - <b>Galipan</b> v. 8000 puerta - <b>Hydro alluminio</b> Domal break pa 52 porta - Domal shops/break 70 porta - Domal stopper/pg porta - <b>Indinvest</b> Gold 500 porta - Gold 600 T.T.porta - <b>K.I. Aluminio s.a.</b> Bw 52 puerta - <b>La semilavorati</b> Lido porta - <b>Metra</b> Nc 45 international porta - Nc 50 nuovo porta - Nc 55 thermic porta - Nc 68 superthermic porta - Superblindo porta - <b>Morelli</b> Ma 9700 porta - <b>New-Tec</b> New-tec 68 super thermal breack porta - New tec 50 New tec 52 T.T. Porta - <b>Ocma</b> Sv 47 porta 1 e 2 ante - Sv 62 porta 1 e 2 ante - Sv 62 T.T. Porta - Fc 60 T.T. Porta - <b>Passerini</b> Ekip 53 thermo porta - <b>Profils systemes</b> Serie 16 - <b>Provedora de aluminio s.a.</b> Optima 1992/45 - <b>Rc system</b> Porta 93-3000 - R.c. confort 60 porta - Aleurotherm 55 n0983 porta - <b>Reynold</b> Reynotherm 55 porta apertura esterna - <b>Schuco</b> Royal 54 - <b>Wicona</b> Serie 5000 apertura esterna
A1001/4	<b>Alcan</b> Point - <b>Alfa Alluminio</b> Euro 40 complanare - Euro 40 sormonto - <b>All.co</b> All.co 5/p4 sormonto zeta reversibile - All.co 5 T.T. sormonto - <b>Al-system</b> Global 48 sormonto - <b>Intrex</b> Overlay - <b>Metra</b> Nc 40 nuovo sormonto 1 anta e sormonto con riporto - Nc 50 nuovo sormonto - <b>Morelli</b> Ma 9600 sormonto <b>New-Tec</b> New-Tec 50 - New-Tec 52 T.T. - <b>Passerini</b> Ekip 40 evoluzione - Ekip 40 sormonto Ekip 50 sormonto - <b>Trafilerie emiliane</b> Sistema 1 sormonto 1 anta complanare esterno 1 anta
A1001/5	<b>Alcoa</b> R40 system sormonto - R40 system reversibile - R50/50 T.T. system sormonto e reversibile R60 T.T. System complanare - <b>New-Tec</b> New-Tec 50 - New-Tec 52 T.T. - <b>Passerini</b> Ekip maas. 53 porta 1 anta
A1001/6	<b>Allco</b> Allco 5/p4 complanare - Allco 5 T.T. complanare - <b>Al-system</b> Global 48 complanare - <b>Aluk</b> Alu-k 45 reversibile/complanare - Alu-k n53 e 55/62/63/70 T.T. - <b>Esa Esa blindall 70</b> - <b>Hydro alluminio</b> Domal security porta <b>Indinvest</b> Alpha 445 porta - <b>Metra</b> Nc 40 nuovo complanare - Nc 50 nuovo complanare - <b>Ocma</b> Fc 45 piana - <b>Passerini</b> Ekip 53 thermo - Ekip 40 complanare - Ekip 50 complanare - Ekip maas th 60 porta - 1 anta - Ekip maas. Th 68 porta 1 anta - <b>Provedora de aluminio s.a.</b> 6000(40x40) <b>Trafilerie emiliane</b> Sistema 1 sormonto 1 anta con riporto e complanare esterno 2 ante - <b>Wicona</b> Wicstyle 60 apertura esterna - <b>Yawal</b> Pi 50 porta apertura esterna
A1001/8	<b>Esa</b> Esa blindall 60 - <b>Heroal</b> Herotherm 030 - <b>Hueck</b> Rd - 2.1 apertura esterna - 1.0 apertura esterna <b>Klauke</b> Serie 2.1 - <b>Metalplast bielsko</b> 60 T.T. apertura esterna - 60 - <b>Passerini</b> Ekip blindo - <b>Reynaers</b> Thermo system 50 porta - Parallel system 50 porta - <b>Reynolds Reynotherm system 620</b> porta apertura esterna - <b>Schuco Royal s 50 n</b> - <b>Profili in ferro</b> Sistema acciaio secco e elegance c55 - Palladio trading Ferro wicstyle 55 - Forster presto, tore, norm 50 - Forster therm
A1001/9	<b>Alcoa</b> Formula F 40 e F 50 System porta - F 40-50-60 T.T. porta all 60 - <b>Indinvest</b> Alpha 255 e Globo 55 - Alpha Blitz e 365/370 T.T. - <b>Morelli</b> MA 9600 Complanare - <b>Trafilerie Emiliane</b> Sistema 1 Complanare
A1001/10	<b>Aluk</b> Aluk 45 porta - <b>Aluk</b> N53 porta -
A1001/11	Per profilo porte con luce da 14 a 16 (tra anta e telaio)

Per i profili segnati in giallo si consigliano i maniglioni con frontale a U - For yellow profile is recommended exit panic device with U-shaped front plate - Pour le profile en jaunes on recommande serrure antipanique avec la têtère en U



## art. A101

“di-più 1 (art. A101)” può essere dotato di micro-switch MC2 (vedi figura)

Il micro-switch **MC2** segnala l'apertura tramite la barra orizzontale

“di-più 1 (art. A101)” peuvent être équipé de micro-interrupteur MC2 (voir figure)

Le micro-interrupteur **MC2** signale l'ouverture par l'intermédiaire de la barre horizontale

“di-più 1 (art. A101)” may be equipped with micro-switch MC2 (see photo)

Micro-switch **MC2** signals the door opening through the horizontal bar

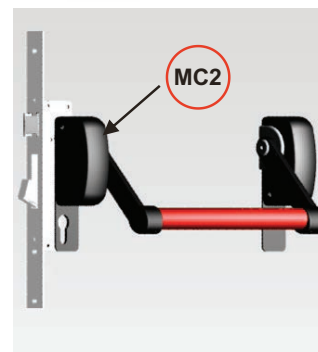

## art. A103

“di-più 3 (art. A103)” può essere dotato di micro-switch in una o due posizioni (vedi figura)

Il micro-switch **MC1** segnala se i catenacci sono aperti  
Il micro-switch **MC2** segnala l'apertura tramite la barra orizzontale

art. **A103** peuvent être équipés de micro-interrupteur sur une ou deux positions (voir figure)

Le micro-interrupteur **MC1** signale si les pènes sont ouverts  
Le micro-interrupteur **MC2** signale l'ouverture par l'intermédiaire de la barre horizontale

“di-più 3 (art. A103)” may be equipped with micro-switches on one or two positions (see photo)

Micro-switch **MC1** signals if dead bolts are open  
Micro-switch **MC2** signals the door opening through the horizontal bar

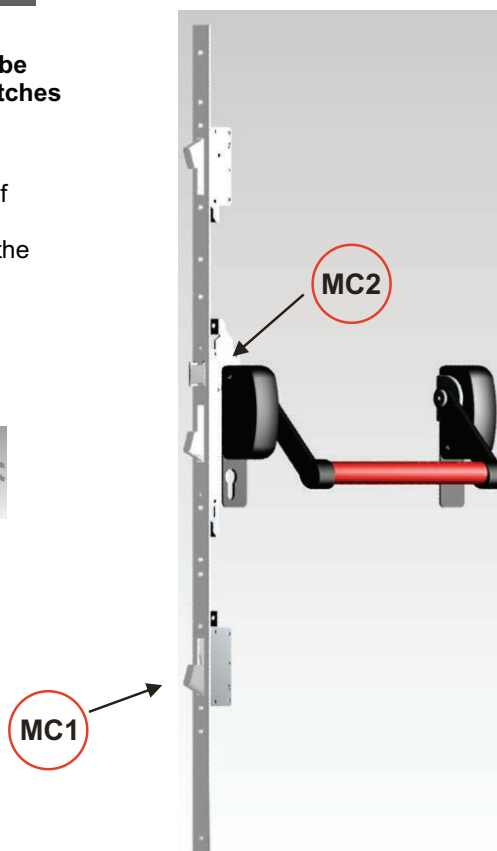

# Maniglione antipanico con serratura



Push Panic device with lock

**art. A103**

ti difende dalle effrazioni - protects you against burglary

## ANTIPANICO DI SICUREZZA A 3 PUNTI DI CHIUSURA

Perfettamente intercambiabile con altri tipi preesistenti

Frontale inox piatto e U da 2285 mm.  
Entrate 25 - 30 e 35 mm.  
Catenacci, scrocco e quadro maniglia in acciaio  
Reversibile

## 3 LOCKING POINTS SECURITY PANIC EXIT DEVICE

S/S flat and U-shaped front plate, 2285 mm.  
Backset 25 - 30 and 35 mm.  
Steel dead bolts, latch bolt and handle hub  
Reversible

## SERRURE ANTIPANIQUE DE SECURITE À 3 POINTS DE FERMETURE

Têtière plate et U en acier inox 2285 mm.  
Axe 25 - 30 et 35 mm.  
Pênes dormants, demi-tour et carré de poignée en acier  
Réversible

confezione - boxing : 1 pz.

imballo - packing: 6 pz.

Cod. Art.	Frontale Front plate 24 mm.	E	A	B
A103U/25T		25	40	34
A103U/30T		30	45	39
A103U/35T		35	50	44
A103PT/25T		25	40	37
A103PT/30T		30	45	42
A103PT/35T		35	50	47

Colori - Colour	
Nero - Black - Noir RAL 9005	
Bianco - White - Blanc RAL 9010	Aggiungere /B al codice Add /B code to the part number Ajouter le code /B
Grigio - Grey - Gris RAL 7040	Aggiungere /G al codice Add /G code to the part number Ajouter le code /G
Grigio RAL 9006	Aggiungere /G6 al codice Add /G6 code to the part number Ajouter le code /G6
Effetto acciaio - Steel finish special finition - Laquage spécial finition acier	Aggiungere /A al codice Add /A code to the part number Ajouter le code /A
Cromo satinato - Satiny chrome Cromé satiné	Aggiungere /TX al codice Add /TX code to the part number Ajouter le code /TX



Classificazione secondo la NUOVA Norma EN 1125:2008

3 - 7 - 6 - 0 - 1 - 4 - 2 - 1 - A - B

### Specifiche di capitolato

Maniglione antipanico **serie A103**

Maniglione antipanico inseribile all'interno di un profilato e dotato di 3 punti di chiusura a catenacci basculanti. Il collegamento tra la serratura interna ed il meccanismo esterno è costituito da uno speciale dispositivo a duplice funzione ambidestro già predisposto a ricevere sia il comando antipanico che la maniglia esterna di servizio (senza alcun intervento dell'applicatore). Dimensioni massime consentite della serratura interna mm. 170x50x19



## incontri specifici-striker for-gâche pour "A103"

Cod. Art.	Profilo - Profile
A1003/1	<b>Agnelli Metalli</b> Esedra GA 53 complanare - Esedra T.T. 63 - Esedra T.T. 75 - <b>Alcan</b> Cristal - Green Keeper 53-60 - <b>Aliplast</b> 50 T.T. - <b>All.co</b> All.co K 40 - Export 40/50 - export 50 T.T. - <b>Alu-mec</b> Synthesis <b>Allumafel</b> Forma serie 31025 - <b>Alusuisse</b> Alsec 2000 - finestra -59 - <b>Anodil</b> Arkial serie Bx - <b>A.ser</b> Riviera serie rinforzata - <b>Bodega</b> Bga 50 - <b>Cortizo</b> Sistema cortizo 60 - <b>Equipe</b> Emal 40w - <b>Ekonal</b> I 70 apertura esterna - <b>Exlabesa</b> Platino puerta pr-7200 - <b>Garcia padrones aluminios s.l.</b> A 93 - <b>Gruppo extrugal</b> 40x40 R.p. 68 -p 45 - R.p. 52 puerta - <b>Hydro alluminio</b> Domal stopper pg - Domal break Pa 52 e 70 <b>Inasa reynold</b> 6040 - 7050 Rt - <b>Indinvest</b> Gold 400 - Gold 500 - <b>Inespal</b> Afill T.T. - Alfil - <b>Kawneer</b> System 1423 - System 1473 - <b>K.L. Aluminio s.a.</b> B.w. 50/52 - B.w. R. 57 - <b>Laminex</b> Star st 15/17 Euro star 9010 - <b>La semilavorati</b> Lido system complanare - <b>Metra</b> Nc 68 superthermic - <b>Morelli</b> Ma 8300 Ma 9500 - <b>Ocma</b> Fc 47 - Fc 55 - Fc 70 hercules - <b>Passerini</b> Ekip thermo sormonto - Ekip base <b>Perfival</b> V/94 - <b>Profils systemes</b> Serie 13 - <b>Provedora de aluminio s.a</b> Optima 1992 - <b>R.c. System</b> Performance 51 - <b>Reynaers</b> Thermo system 50/57 - Parallel system 50 - <b>Sunparadise</b> Fiesta 42 Thermo 60 - <b>Technal</b> Pbi - Pxi apertura esterna - Pbi new - <b>Trafileria emiliane</b> Eku 64 T.T. - <b>Van Beveren</b> Serie R 50 e Bb 50 - <b>Wicona</b> Serie 70000 - L/50 apertura esterna
A1003/2	<b>Alcan</b> Green porta 1 anta - Green porta 1 anta con riporto - Open porta 1 anta - Open porta 1 anta con riporto - <b>Alcoa</b> Alublind - <b>All.co</b> All.co 5 porta - All.co 5 T.T. Porta - Sicurblind porta - <b>Alumafel</b> Forma serie 31020 - <b>Alusuisse</b> Alsec 2000 59 porta Alsec 2000 69 porta - <b>Exlabesa</b> 3000 puerta - <b>Fwb brokelmann aluminium</b> serie TF porta - <b>Galipan</b> v. 8000 puerta - <b>Hydro alluminio</b> Domal break pa 52 porta - Domal shops/break 70 porta - Domal stopper/pg porta - <b>Indinvest</b> Gold 500 porta - Gold 600 T.T.porta - <b>K.I. Aluminio s.a.</b> Bw 52 puerta - <b>La semilavorati</b> Lido porta - <b>Metra</b> Nc 45 international porta - Nc 50 nuovo porta - Nc 55 thermic porta - Nc 68 superthermic porta - Superblindo porta - <b>Morelli</b> Ma 9700 porta - <b>New-Tec</b> New-tec 68 super thermal breack porta - New tec 50 New tec 52 T.T. Porta - <b>Ocma</b> Sv 47 porta 1 e 2 ante - Sv 62 porta 1 e 2 ante - Sv 62 T.T. Porta - Fc 60 T.T. Porta - <b>Passerini</b> Ekip 53 thermo porta - <b>Profils systemes</b> Serie 16 - <b>Provedora de aluminio s.a.</b> Optima 1992/45 - <b>Rc system</b> Porta 93-3000 - R.c. confort 60 porta - Aleurotherm 55 n0983 porta - <b>Reynold</b> Reynotherm 55 porta apertura esterna - <b>Schuco</b> Royal 54 - <b>Wicona</b> Serie 5000 apertura esterna
A1003/4	<b>Alcan</b> Point - <b>Alfa Alluminio</b> Euro 40 complanare - Euro 40 sormonto - <b>All.co</b> All.co 5/p4 sormonto zeta reversibile - All.co 5 T.T. sormonto - <b>Al-system</b> Global 48 sormonto - <b>Intrex</b> Overlay - <b>Metra</b> Nc 40 nuovo sormonto 1 anta e sormonto con riporto - Nc 50 nuovo sormonto - <b>Morelli</b> Ma 9600 sormonto <b>New-Tec</b> New-Tec 50 - New-Tec 52 T.T. - <b>Passerini</b> Ekip 40 evoluzione - Ekip 40 sormonto Ekip 50 sormonto - <b>Trafilerie emiliane</b> Sistema 1 sormonto 1 anta complanare esterno 1 anta
A1003/5	<b>Alcoa</b> R40 system sormonto - R40 system reversibile - R50/50 T.T. system sormonto e reversibile R60 T.T. System complanare - <b>New-Tec</b> New-Tec 50 - New-Tec 52 T.T. - <b>Passerini</b> Ekip maas. 53 porta 1 anta
A1003/6	<b>Allco</b> Allco 5/p4 complanare - Allco 5 T.T. complanare - <b>Al-system</b> Global 48 complanare - <b>Aluk</b> Alu-k 45 reversibile/complanare - Alu-k n53 e 55/62/63/70 T.T. - <b>Esa</b> <b>Esa blindall 70</b> - <b>Hydro alluminio</b> Domal security porta <b>Indinvest</b> Alpha 445 porta - <b>Metra</b> Nc 40 nuovo complanare - Nc 50 nuovo complanare - <b>Ocma</b> Fc 45 piana - <b>Passerini</b> Ekip 53 thermo - Ekip 40 complanare - Ekip 50 complanare - Ekip maas th 60 porta - 1 anta - Ekip maas. Th 68 porta 1 anta - <b>Provedora de aluminio s.a.</b> 6000(40x40) <b>Trafilerie emiliane</b> Sistema 1 sormonto 1 anta con riporto e complanare esterno 2 ante - <b>Wicona</b> Wicstyle 60 apertura esterna - <b>Yawal</b> Pi 50 porta apertura esterna
A1003/8	<b>Esa</b> Esa blindall 60 - <b>Heroal</b> Herotherm 030 - <b>Hueck</b> Rd - 2.1 apertura esterna - 1.0 apertura esterna <b>Klauke</b> Serie 2.1 - <b>Metalplast bielsko</b> 60 T.T. apertura esterna - 60 - <b>Passerini</b> Ekip blindo - <b>Reynaers</b> Thermo system 50 porta - Parallel system 50 porta - <b>Reynolds Reynotherm system 620</b> porta apertura esterna - <b>Schuco Royal s 50 n</b> - <b>Profili in ferro</b> Sistema acciaio secco e elegance c55 - Palladio trading Ferro wicstyle 55 - Forster presto, tore, norm 50 - Forster therm
A1003/9	<b>Alcoa</b> Formula F 40 e F 50 System porta - F 40-50-60 T.T. porta all 60 - <b>Indinvest</b> Alpha 255 e Globo 55 - Alpha Blitz e 365/370 T.T. - <b>Morelli</b> MA 9600 Complanare - <b>Trafilerie Emiliane</b> Sistema 1 Complanare
A1003/10	<b>Aluk</b> Aluk 45 porta - <b>Aluk</b> N53 porta -
A1003/11	Per profilo porte con luce da 14 a 16 (tra anta e telaio)

Per i profili segnati in giallo si consigliano i maniglioni con frontale a U - For yellow profile is recommended exit panic device with U-shaped front plate - Pour le profile en jaunes on recommande serrure antipanique avec la têtère en U



# Maniglione antipanico con serratura porte due ante



Push Panic device with lock for double doors

## A105 - A106

antipanico di sicurezza per 2 ante con 5 punti di chiusura

### tipo unico per tutti i "profili porta"

Frontale inox U per porte fino a 2600 mm.

Entrate 30 e 35 mm.

Reversibile

**Tutti gli incontri (alto, basso e centrale) sono già compresi nella confezione dell'art. 106** e adatti a tutti i "profili porta" con luce da 18 a 28 mm.

### 5 LOCKING MORTICE PANIC EXIT DEVICE FOR DOUBLE METAL DOORS

U Inox front plate

Backset 30 and 35 mm.

Reversible

All strikers (central, top and bottom) included

### ANTIPANIQUE A MORTAISER POUR PORTE METALLIQUE DOUBLE A 5 POINTS DE FERMETURE

Tête U en acce inox

Axe 30 et 35 mm.

Réversible

Gâche centrale, haute et bas inclus dans l'emballage

**N.B. Le versioni anta principale e anta secondaria sono VENDUTE SEPARATAMENTE. Per l'acquisto del solo art. 105 aggiungere il kit incontro art. 1005 a pag. 38**

confezione - boxing : 1 pz.  
imballo - packing: 6 pz.

### anta principale - main door leaf ventail principal

Cod. Art.	Frontale Front plate 24 mm.	E	A	B
A105U/30		30	45	39
A105U/35		35	50	44

### anta secondaria - second door leaf ventail secondaire

Cod. Art.	Frontale Front plate 24 mm.	E	A	B
A106U/30		30	45	39
A106U/35		35	50	44
A106U/60		60	75	69

Studiato per i profili di riporto



Classificazione secondo la NUOVA Norma EN 1125:2008

3 - 7 - 6 - 0 - 1 - 4 - 2 - 1 - A - A

Colori - Colour	
Nero - Black - Noir RAL 9005	
Bianco - White - Blanc RAL 9010	Aggiungere /B al codice Add /B code to the part number Ajouter le code /B
Grigio - Grey - Gris RAL 7040	Aggiungere /G al codice Add /G code to the part number Ajouter le code /G
Grigio RAL 9006	Aggiungere /G6 al codice Add /G6 code to the part number Ajouter le code /G6
Effetto acciaio - Steel finish special finition - Laquage spécial finition acier	Aggiungere /A al codice Add /A code to the part number Ajouter le code /A
Cromo satinato - Satiny chrome Cromé satiné	Aggiungere /TX al codice Add /TX code to the part number Ajouter le code /TX

### Specifiche di capitolato

Maniglione antipanico "di-più 2 ante Serie 105-106"

Maniglione antipanico di-più 2 ante Serie 105-106 funzionante ad aste esterne e con interasse tra cilindro e maniglia mm. 85.

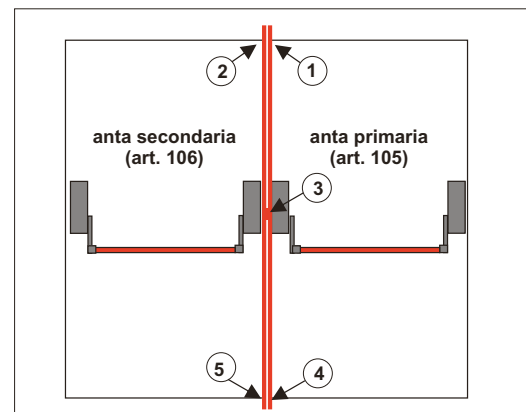

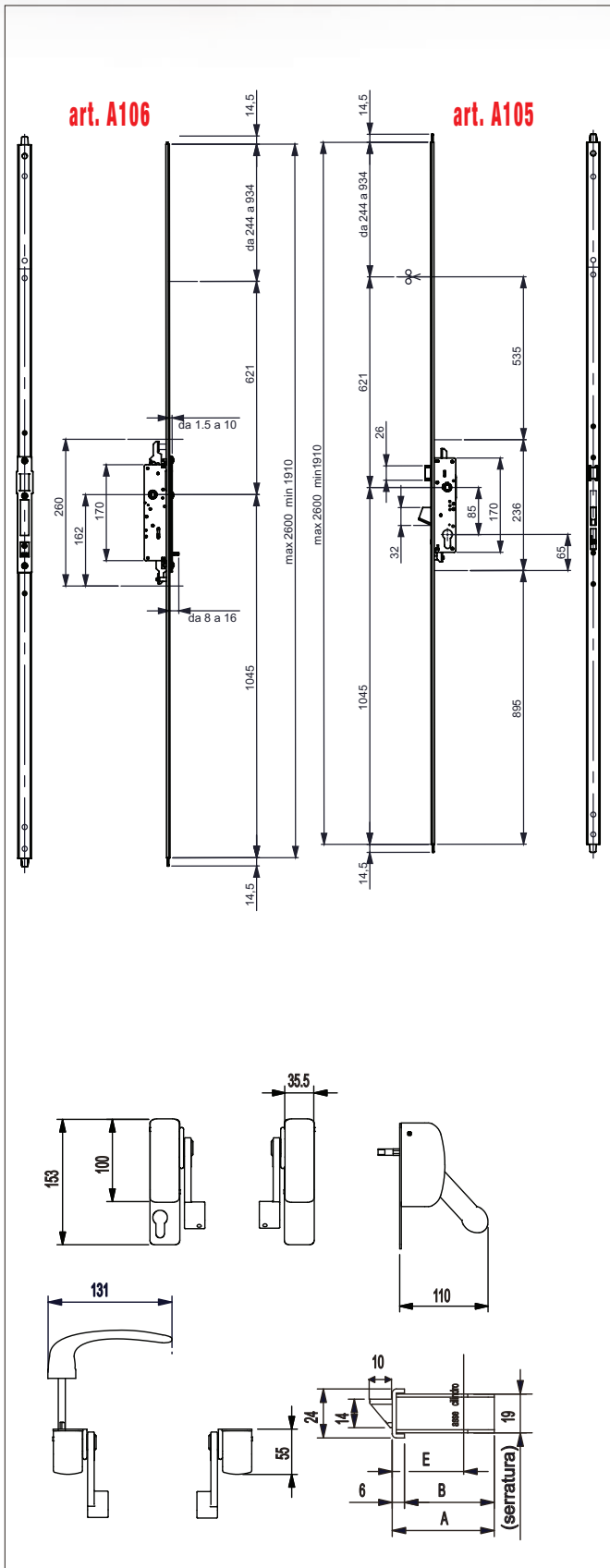

Patented



**KIT INCONTRO ALTO/BASSO PER ART. 105**  
**STRIKER TOP/BOTTOM FOR ART. 105**  
**GÂCHE AUT/BAS POUR ART. 105**

Cod.Art.
A1005

PER L'INCONTRO CENTRALE VEDERE ART. 1001/xx A PAG. 18  
 FOR SIDE STRIKER SEE ART. 1001/xx PAGE 18  
 POUR GÂCHE LATÉRALE VOIR ART. 1001/xx PAG 18

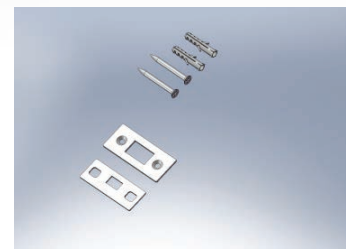
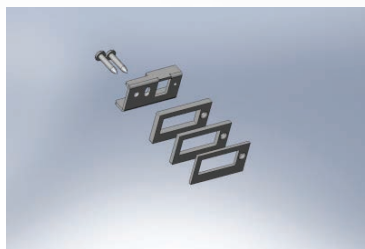

confezione - boxing : 1 pz.

## accessori "PUSH BAR / TOUCH BAR"

**KIT ASTE e SCROCCHI ALTO/BASSO - VERTICAL RODS AND LATCH BOLTS - KIT TRINGLES ET PÊNES VERTICAUX**

Cod.Art.	A	B	Colore - Colour
A450/T	1030	1490	Nero - Black - Noir RAL 9005
A450L/T	1030	2000	
A450/TG	1030	1490	Grigio - Grey - Gris RAL 7040 o RAL 9006 Aggiungere /G6 al codice
A450L/TG	1030	2000	
A450/TB	1030	1490	Bianco - White - Blanc RAL 9010
A450L/TB	1030	2000	
A450/TA	1030	1490	Verniciatura effetto acciaio Steel finish special painting Lacquage spécial finition acier
A450L/TA	1030	2000	
A450/TX	1030	1490	Cromo satinato - Satiny chrome Chrome satinée

confezione - boxing : 1 pz.

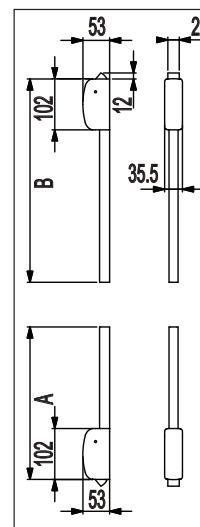

Finitura a richiesta - Finition on request - Finition on demande: O = Ottonato - Brass finisced - Finition laiton

**KIT ASTE e SCROCCHI LATERALI - VERTICAL RODS AND LATERAL LATCH BOLTS - KIT TRINGLES ET PÊNES LATÉRAUX**

Cod.Art.	A	B	Colore - Colour
A455/T	1030	1490	Nero - Black - Noir RAL 9005
A455L/T	1030	2000	
A455/TG	1030	1490	Grigio - Grey - Gris RAL 7040 o RAL 9006 Aggiungere /G6 al codice
A455L/TG	1030	2000	
A455/TB	1030	1490	Bianco - White - Blanc RAL 9010
A455L/TB	1030	2000	
A455/TA	1030	1490	Verniciatura effetto acciaio Steel finish special painting Lacquage spécial finition acier
A455L/TA	1030	2000	
A455/TX	1030	1490	Cromo satinato - Satiny chrome Chrome satinée

confezione - boxing : 1 pz.

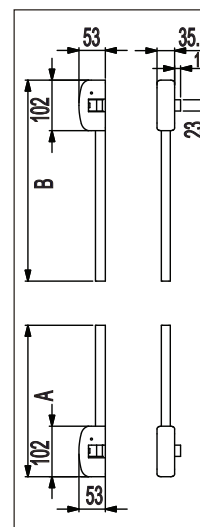

Finitura a richiesta - Finition on request - Finition on demande: O = Ottonato - Brass finisced - Finition laiton



**KIT ASTE e SCROCCHI VERTICALI E LATERALI**  
**VERTICAL RODS AND VERTICAL AND LATERAL LATCH BOLTS**  
**KIT TRINGLES ET PÊNES VERTICAUX ET LATÉRAUX**

confezione - boxing : 1 pz.

Cod.Art.	A	B	Colore - Colour
A452/T	1030	1490	Nero - Black - Noir RAL 9005
A452L/T	1030	2000	
A452/TG	1030	1490	Grigio - Grey - Gris RAL 7040 o RAL 9006 Aggiungere /G6 al codice
A452L/TG	1030	2000	
A452/TB	1030	1490	Bianco - White - Blanc RAL 9010
A452L/TB	1030	2000	
A452/TA	1030	1490	Verniciatura effetto acciaio Steel finish special painting Laquage spécial finition acier
A452L/TA	1030	2000	
A452/TX	1030	1490	Cromo satinato - Satiny chrome Chrome satinée



Aggiungere DX oppure  
 SX al codice  
 Add DX or SX code to  
 the part number  
 Ajouter DX ou SX  
 au code



Finitura a richiesta - Finition on request - Finition on demande: O = Ottonato - Brass finished - Finition laiton



## comandi esterni per "PUSH BAR / TOUCH BAR"

### GRUPPO CILINDRO MANIGLIA

In lega pressofusa verniciata

#### OUTSIDE TRIM

Painted pressure die-cast alloy

#### MODULE EXTERIEUR

En alliage moulé sous pression et laqué

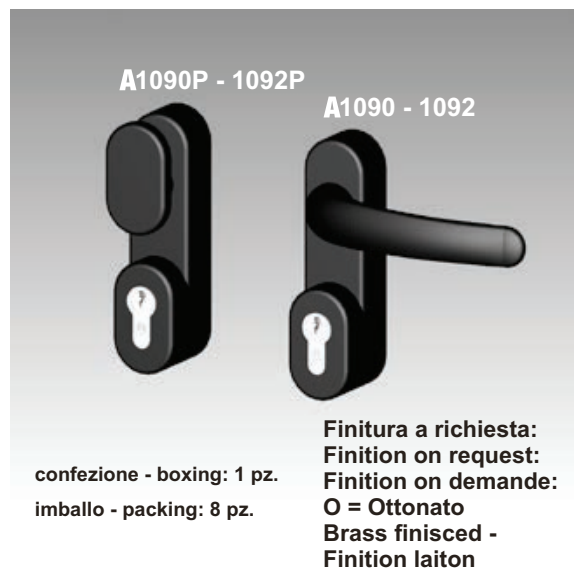
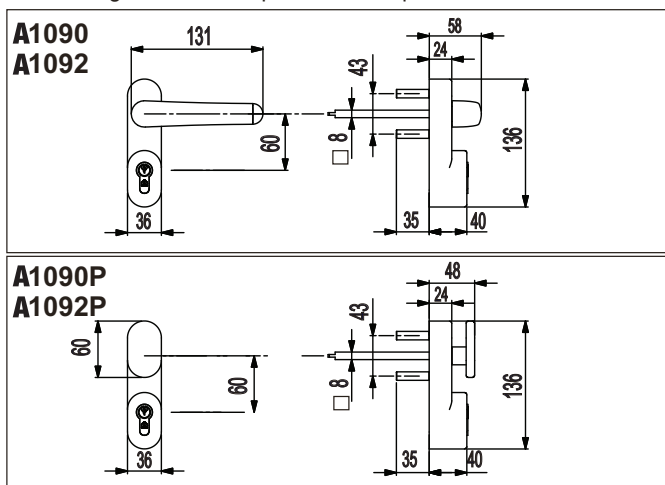

Cod.Art.	Colore - Colour	Con maniglia With handle Avec module exterieure	Cod.Art.	Colore - Colour	Con maniglia With handle Avec module exterieure
A1090	Nero - Black - Noir RAL 9005	Cilindro europeo Europrofile cylinder Cylindre à profil européen	A1090P	Nero - Black - Noir RAL 9005	Cilindro europeo Europrofile cylinder Cylindre à profil européen
A1090/G	Grigio - Grey - Gris RAL 7040		A1090P/G	Grigio - Grey - Gris RAL 7040	
A1090/G6	Grigio RAL 9006		A1090P/G6	Grigio RAL 9006	
A1090/B	Bianco - White - Blanc RAL 9010		A1090P/B	Bianco - White - Blanc RAL 9010	
A1090/A	Verniciatura effetto acciaio Steel finish special painting Laquage spécial finition acier		A1090P/A	Verniciatura effetto acciaio Steel finish special painting Laquage spécial finition acier	
A1090/X	Cromo satinato - Satiny chrome - Chrome satinée		A1090P/X	Cromo satinato - Satiny chrome - Chrome satinée	
Cod.Art.	Colore - Colour	Con maniglia With handle Avec module exterieure	Cod.Art.	Colore - Colour	Con maniglia With handle Avec module exterieure
A1090/SC	Nero - Black - Noir RAL 9005	Come Art. 1090, senza cilindro Like Art. 1090, but without cylinder Comme Art. 1090, mais sans cylindre	A1090P/SC	Nero - Black - Noir RAL 9005	Come Art. 1090, senza cilindro Like Art. 1090, but without cylinder Comme Art. 1090, mais sans cylindre
A1090/G/SC	Grigio - Grey - Gris RAL 7040		A1090P/G/SC	Grigio - Grey - Gris RAL 7040	
A1090/B/SC	Bianco - White - Blanc RAL 9010		A1090P/B/SC	Bianco - White - Blanc RAL 9010	
A1090/A/SC	Verniciatura effetto acciaio Steel finish special painting Laquage spécial finition acier		A1090P/A/SC	Verniciatura effetto acciaio Steel finish special painting Laquage spécial finition acier	

### GRUPPO CILINDRO MANIGLIA RIBASSATA

IDEALE PER PORTONI INDUSTRIALI - In lega pressofusa verniciata

#### SLIM OUTSIDE ACCES

Painted pressure die-cast alloy

#### MODULE EXTERIEUR REDUITE

En alliage moulé sous pression et laqué

Cod.Art. A1090R

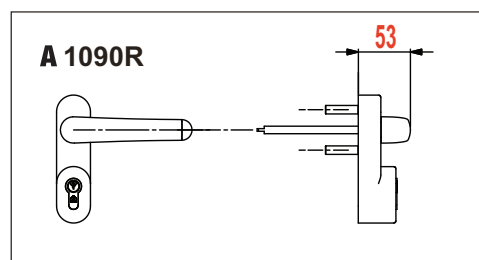

## comandi esterni versioni condominio per "PUSH BAR / TOUCH BAR"

### GRUPPO CILINDRO MANIGLIA VERSIONE CONDOMINIO

In lega pressofusa verniciata

#### SECURISED OUTSIDE ACCESS

Painted pressure die-cast alloy

#### MODULE EXTERIEUR SECURISÉE

En alliage moulé sous pression et laqué

Cod.Art.	Colore - Colour	Con maniglia With handle Avec module exterieure	Cod.Art.	Colore - Colour	Con maniglia With handle Avec module exterieure
A1092	Nero - Black - Noir RAL 9005	Cilindro europeo Europrofile cylinder Cylindre à profil européen	A1092P	Nero - Black - Noir RAL 9005	Cilindro europeo Europrofile cylinder Cylindre à profil européen
A1092/G	Grigio - Grey - Gris RAL 7040		A1092P/G	Grigio - Grey - Gris RAL 7040	
A1092/G6	Grigio RAL 9006		A1092P/G6	Grigio RAL 9006	
A1092/B	Bianco - White - Blanc RAL 9010		A1092P/B	Bianco - White - Blanc RAL 9010	
A1092/A	Verniciatura effetto acciaio Steel finish special painting Laquage spécial finition acier		A1092P/A	Verniciatura effetto acciaio Steel finish special painting Laquage spécial finition acier	
A1092/X	Cromo satinato - Satiny chrome - Chrome satinée		A1092P/X	Cromo satinato - Satiny chrome - Chrome satinée	
Cod.Art.	Colore - Colour	Con maniglia With handle Avec module exterieure	Cod.Art.	Colore - Colour	Con maniglia With handle Avec module exterieure
A1092/SC	Nero - Black - Noir RAL 9005	Come Art. 1092, senza cilindro Like Art. 1092, but without cylinder Comme Art. 1092, mais sans cylindre	A1092P/SC	Nero - Black - Noir RAL 9005	Come Art. 1092, senza cilindro Like Art. 1092, but without cylinder Comme Art. 1092, mais sans cylindre
A1092/G/SC	Grigio - Grey - Gris RAL 7040		A1092P/G/SC	Grigio - Grey - Gris RAL 7040	
A1092/B/SC	Bianco - White - Blanc RAL 9010		A1092P/B/SC	Bianco - White - Blanc RAL 9010	
A1092/A/SC	Verniciatura effetto acciaio Steel finish special painting Laquage spécial finition acier		A1092P/A/SC	Verniciatura effetto acciaio Steel finish special painting Laquage spécial finition acier	

## solo cilindro

### SOLO CILINDRO

Consigliato per maniglioni ad 1 punto di chiusura e maniglioni elettrici

### ONLY CYLINDER

Better for electric and 1 locking point panic device

### CYLINDRE SEULEMENT

Préférable pour antipanique électriques et à 1 point de fermeture

Cod.Art. 1040

confezione - boxing : 1 pz.

imballo - packing: 8 pz.

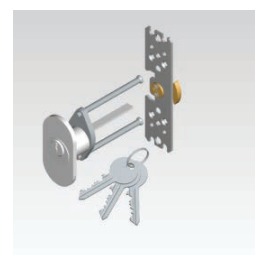

## solo maniglia

### MECCANISMO PER ANTIPANICO SOLO MANIGLIA ETERNA - ONLY HANDLE POIGNÉE SEULE

Cod.Art.	Colore - Colour
A1081	Nero - Black - Noir
A1081/G	Grigio - Grey - Gris
A1081/B	Bianco - White - Blanc

Cod.Art.	Colore - Colour
A1081/A	Verniciatura effetto acciaio - Steel finish special painting - Laquage spécial finition acier
A1081/X	Cromo satinato - Satiny chrome - Chrome satinée

Finitura a richiesta - Finition on request - Finition on demande:  
O = Ottonato - Brass finisced - Finition laiton



confezione - boxing : 1 pz.  
imballo - packing: 8 pz.

