



# MINIMAL





**CARATTERISTICHE TECNICHE:**  
**TECHNICAL CHARACTERISTICS:**

La serie è dotata di cartuccia a dischi ceramici, Ø 35 mm, prodotta da S.T.S.R. – Studio Tecnico Sviluppo e Ricerche - [www.stsr.it](http://www.stsr.it)

The series is equipped with ceramic cartridge, Ø 35 mm, produced by S.T.S.R. - Research Development Technical Office - [www.stsr.it](http://www.stsr.it)

Finiture disponibili: cromo, bianco opaco, nero opaco, satinato.

Available finishes: chrome, matt white, matt black, satin.

**MANIGLIE:**  
**LEVERS:**

N 10



N 10 2



N 10 3



Elegante e raffinata, la linea Minimal si pone come icona del nuovo millennio in termini di modernità estetica e costruttiva.

L'interpretazione modello di forme completamente arrotondate viene interrotta dal taglio obliquo della bocca di erogazione e dal particolare della maniglia che, piegandosi leggermente all'insù, ci porta a visioni di rinnovata positività. Questa rubinetteria si

posiziona sicuramente tra i classici del moderno.

Il design della serie è stato ideato dal Gruppo di Ricerca e Sviluppo di Remer Rubinetterie ed ingegnerizzata e prodotta nei nostri stabilimenti produttivi situati in provincia di Milano.

# MINIMAL



**SIMBOLOGIE:  
SYMBOLOLOGY:**

  
Con scarico con  
Troppo Pieno  
With waste  
with Overflow

  
Senza scarico  
Without waste

  
Con Click-Clack  
With Click-Clack

  
Proporzione perfetta.  
The right proportion.

  
Con getto a cascata.  
With waterfall jet.

  
Con multigetto.  
With multi jet.

  
Con Kit Doccia e flessibile  
lungo: 120, 150 o 200 cm  
With Shower Kit and flexible  
long: 120, 150, 200 cm

  
Doccetta Anticalcare  
Anti-limestone Hand Shower

  
**SELF-CLEANING**  
Soffione Anticalcare ed  
Autopulente  
Anti-limestone and Self-cleaning  
Shower Head

  
Getti Anticalcare  
Anti-limestone Jets

  
Colonna doccia  
girevole.  
Swivable  
shower column.

  
Corpo girevole  
Swivable body.

  
Canna girevole  
Movable spout.

  
**HIGH**  
Canna alta girevole  
High movable spout.

*Elegant and refined, the Minimal line stands as an icon of the new millennium in terms of aesthetical and constructive modernity.*

*The model interpretation of fully rounded forms is interrupted by the oblique cut of the spout and by the handle particular that, slightly bending upward, brings us a renewed vision of positivity. This taps series is indeed positioned between the*

*classics of modern.*

*The design of this line has been created by the Research and Development Group of Remer Rubinetterie and ingegnerized and produced in Remer production facilities located in Milan province.*

# MINIMAL





## Lavabi Washbasins



**N 10**  
Miscelatore monocomando lavabo.  
Single-lever basin mixer.



**N 11**  
Miscelatore monocomando lavabo.  
Single-lever basin mixer.



**N 10 A**  
Miscelatore monocomando lavabo.  
Single-lever basin mixer.



**N 11 A**  
Miscelatore monocomando lavabo.  
Single-lever basin mixer.



**N 10 L**  
Miscelatore monocomando lavabo alto L, su colonna.  
Single-lever basin mixer, L high neck.



**N 10 L B**  
Miscelatore monocomando lavabo alto L, su colonna.  
Single-lever basin mixer, L high neck.



**N 11 L**  
Miscelatore monocomando lavabo alto L, su colonna.  
Single-lever basin mixer, L high neck.



**N 10 LXL**  
Miscelatore monocomando lavabo alto LXL, su colonna.  
Single-lever basin mixer, LXL high neck.



**N 10 LXL B**  
Miscelatore monocomando lavabo alto LXL, su colonna.  
Single-lever basin mixer, LXL high neck.



**N 11 LXL**  
Miscelatore monocomando lavabo alto LXL, su colonna.  
Single-lever basin mixer, LXL high neck.

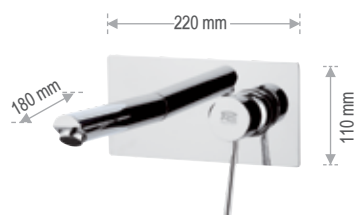

**N 15**  
Miscelatore monocomando a incasso con piastra rettangolare in ottone cromato e bocca minimal.

Single lever built-it basin mixer with rectangular wall flange in chrome plated brass and minimal spout.



**N 14**  
Miscelatore monocomando a incasso per lavabo con piastra verticale rettangolare in ottone cromato e bocca minimal.

Single lever built-it basin mixer with vertical rectangular wall flange in chrome plated brass and minimal.

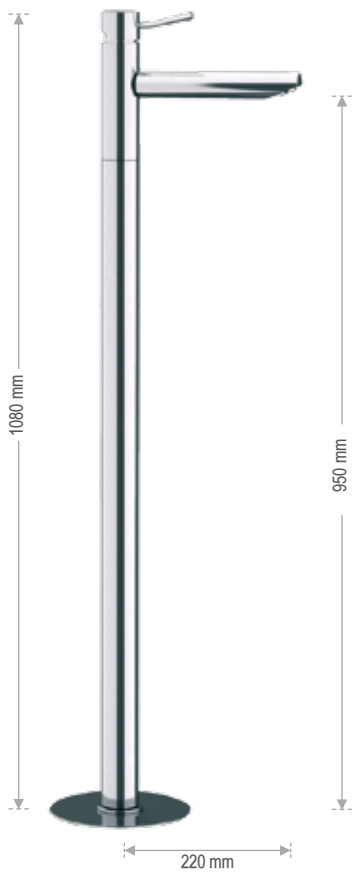

**N 18**  
Miscelatore monocomando lavabo da terra.  
Single-lever mixer for floor mounting.



**N 17**

Miscelatore da soffitto in ottone cromato lunghezza 166 cm, con miscelazione e controllo flusso integrati nella bocca di erogazione.

Ceiling mixer in chrome plated brass cm 166, with mixing and flow control integrated in the outlet spout.

**N 17 L**

Miscelatore da soffitto in ottone cromato lunghezza 181 cm, con miscelazione e controllo flusso integrati nella bocca di erogazione.

Ceiling mixer in chrome plated brass cm 181, with mixing and flow control integrated in the outlet spout.







## Bidet Bidet



**N 20**  
Miscelatore monocomando per bidet,  
con aeratore direzionabile.  
Single-lever bidet mixer with adjustable  
aerator.



**N 21**  
Miscelatore monocomando per bidet,  
con aeratore direzionabile.  
Single-lever bidet mixer with adjustable  
aerator.



**N 24**  
Miscelatore monocomando per bidet,  
con deviatore e doccia.  
Single-lever bidet mixer with diverter  
and spray.

**N 23**  
Miscelatore monocomando per bidet,  
con doccia.  
Single-lever bidet mixer with spray.



**N 60**  
Miscelatore incasso per shut-off  
comprensivo di: doccia shut-off  
art 332 OL, supporto doccia- presa  
acqua su piastra in ottone cromato e  
flessibile doccia cm 120.

Built-in shut-off mixer set including :  
shut.off art 332 OL, shower holderwater  
punch on flange, all in c.p. brass and  
shower flexible cm 120.



**N 63**  
Miscelatore incasso per shut-off.  
Built-in shut-off mixer.

## Vasca Bath Mixer



**N 02**  
Miscelatore monocomando per vasca, esterno, con doccia duplex.

Wall mounted single-lever bath mixer with duplex shower.



**N 05**  
Miscelatore monocomando per vasca, esterno, senza doccia.

Wall mounted single-lever bath mixer without shower.



**N 03**  
Miscelatore monocomando lavabo/vasca, con deviatore integrato e kit doccia.

Single lever basin/bath mixer with diverter and shower kit.



**N 06**  
Miscelatore monocomando bordo vasca con deviatore, bocca con effetto multigetto e doccetta in ABS a 4 funzioni.

Single lever deck bath/shower mixer with diverter, spout with multijets effect and 4 functions ABS brass hand shower.



**N 06 317 MM**  
Miscelatore monocomando bordo vasca con deviatore, bocca con effetto multigetto e doccetta in ottone cromato.

Single lever deck bath/shower mixer with diverter, spout with multijets effect and c.p. brass hand shower.



**N 07**  
Miscelatore monocomando bordo vasca serie Minimal con deviatore a molla, bocca minimale e doccetta minimale in ottone cromato.

Single lever deck bath/shower mixer serie Minimal with spring diverter, with minimal spout and minimal chrome plated brass hand shower.



**N 27**  
Miscelatore bordo vasca con deviatore e doccetta minimale.



**N 04**  
Miscelatore monocomando a incasso per vasca, su piastra rettangolare, con bocca lunga cm 18, deviatore e kit doccia integrato.



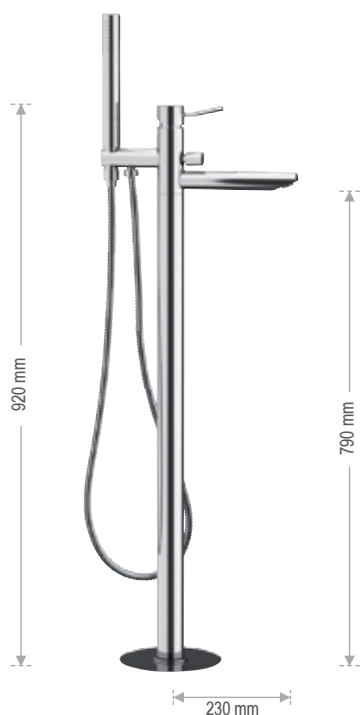

**N 08**  
Miscelatore vasca da pavimento con deviatore e kit doccia.

Single-lever bath mixer floor mounting with diverter and shower kit.

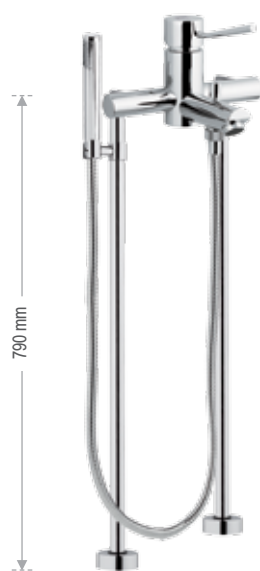

**N 02 XL**  
Gruppo vasca esterno su colonne da pavimento Minimal, con doccia.

Traditional bathtub mixer, on Minimal floor columns, with shower.

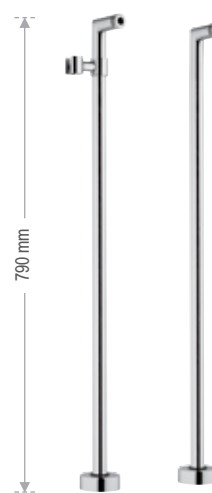

**88 N 02**  
Coppia colonne vasca in ottone cromato, serie Minimal, con supporto doccia, 3/4M x 3/4M.

Couple c.p. brass vertical connections for bath mixer, serie Minimal, with hand shower holder 3/4M x 3/4M.

## Bocche Spouts



**91 M**  
Bocca incasso per miscelatore vasca-doccia, cm 18.  
Built-in spout for bath-shower mixer, cm 18.



**91 MD**  
Bocca incasso per miscelatore vasca-doccia, con deviatore integrato, cm 18.  
Built-in spout for bath-shower mixer, with diverter, cm 18.



**91 N2**  
Bocca incasso per miscelatore vasca-doccia, cm 18.  
Built-in spout for bath-shower mixer, cm 18.

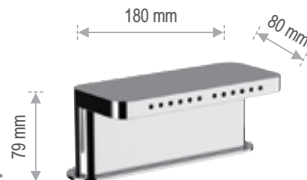

**91 NCF**  
Bocca bordo vasca con angoli arrotondati.  
Spout for deck bath/shower with rounded corners.

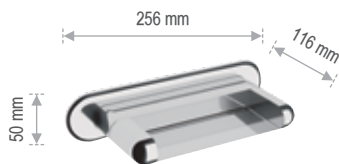

**91 NC**  
Bocca incasso con bordi arrotondati.  
Built-in spout with rounded corners.

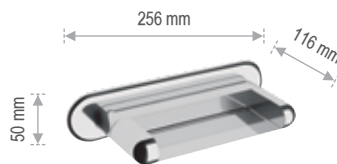

**359 NC**  
Soffione doccia con bordi arrotondati.  
C.p. brass shower head with rounded corners.



**91 V N2**  
Bocca da soffitto in ottone cromato  
lunghezza 166 cm.  
Ceiling spout in chrome plated brass cm 166.



**91 VL N2**  
Bocca da soffitto in ottone cromato  
lunghezza 181 cm.  
Ceiling spout in chrome plated brass cm 181.



## Incassi

Tramite la scelta di questi incassi doccia, con o senza deviazioni, quindi da una via a 5 vie, potrai costruirti il tuo set doccia preferito (oltre a quelli già proposti come combinazioni suggerite) utilizzando gli articoli proposti nella sezione doccia: doccette da pag. 436, saliscendi da pag. 422, bracci doccia da pag. 462, soffioni doccia da pag. 458, getti a pag. 465-466, bocche di erogazione da pag. 394, colonne doccia da pag. 470, supporti doccia a pag. 454. Ricordati di combinarli con la presa acqua (a pag. 442 doccette e a pag. 484 per colonne) ed il flessibile doccia desiderato (a pag. 486).

Più elementi inserirete più il miscelatore dovrà comprendere la possibilità di deviare il flusso da un elemento all'altro, ad esclusione di soluzioni con il deviatore integrato, vedi deviatore integrato su colonne doccia, su braccio doccia, su bocca di erogazione, etc.

Il Vostro rivenditore saprà comunque consigliarvi al meglio.

## Built-in mixers

With your choice of these built-in showers, with or without diverters, which means from 1 to 5 ways, you will be able to built your favorite shower set (in addition to the combinations already suggested) by using the items proposed in the shower section: hand showers from page 436, Sliding rails from page 442, shower arms on page 462 and shower heads from page 458, jets on page 465-466, spouts from page 394, shower columns from page 470 and shower holder from page 454. Remember to combine them with the water punch (page 442 for hand shower and page 484 for columns) and the shower flexible you prefer (page 486).

More output elements you'll insert, more your mixer will have to include the possibility of diverting the flow from one element to the other, excluding those solutions that have integrated diverters, like shower columns with diverter, shower arm with diverter, spout with diverter etc Your sales consultant will be able available for any suggestion.



**N 30**  
Miscelatore monocomando incasso per doccia.  
Single lever built-in shower mixer.



**N 09**  
Miscelatore monocomando incasso con deviatore per vasca/doccia.  
Single lever built-in bath/shower mixer with diverter.



**N 30 L**  
Miscelatore monocomando incasso per doccia, con piastra lusso.  
Single lever built-in shower mixer, with deluxe flange.



**N 09 L**  
Miscelatore monocomando incasso con deviatore per vasca/doccia, con piastra lusso.  
Single lever built-in bath/shower mixer with diverter, with deluxe flange.



**N 92**  
Miscelatore monocomando a incasso per doccia, con deviatore a due posizioni (due uscite ed una entrata) su piastra unica.  
Single-lever built-in shower mixer with 2 positions diverter (2 outlets and 1 inlet) on single flange.



**N 93**  
Miscelatore monocomando per doccia con deviatore a tre vie (una entrata e tre uscite) su unica piastra.  
Single lever built-in shower mixer with three ways diverter (1 inlet and 3 outlets) on single flange.



**N 94**  
Miscelatore monocomando per doccia, con deviatore a 4 posizioni (4 uscite ed 1 entrata) su piastra unica.  
Single-lever shower mixer with 4 positions diverter (4 outlets and 1 inlet,) on single flange.



**N 95 C**  
Miscelatore monocomando per doccia, con deviatore a 5 posizioni (5 uscite ed una entrata) su doppia piastra, con possibilità di chiusura del flusso dal deviatore durante il cambio di posizione (col vantaggio di non azionare posizioni non desiderate e non dover toccare la maniglia che seleziona anche la temperatura).  
Single-lever shower mixer with 5 positions diverter (5 outlets and 1 inlet) on double flange, with the possibility of closing the flow from the diverter during the position change (with the advantage of not starting the undesired positions and also not be forced to touch the handle that also selects the temperature).

**N 93 7**  
Miscelatore monocomando per doccia con deviatore a tre vie e sette posizioni (una entrata, tre uscite e sette posizioni con cui selezionare uscite singole o miscelate tra loro) su unica piastra.  
Scatti della maniglia-deviatore:  
lo scatto 1 aziona l'acqua dell'uscita 1  
lo scatto 2 aziona l'acqua dell'uscita 2  
lo scatto 3 aziona l'acqua dell'uscita 3  
lo scatto 4 aziona l'acqua dell'uscita 1  
lo scatto 5 aziona l'acqua delle uscite 1 + 2  
lo scatto 6 aziona l'acqua delle uscite 1 + 2 + 3  
lo scatto 7 aziona l'acqua delle uscite 2 + 3

Single lever built-in shower mixer with three ways diverter seven positions (1 inlet, 3 outlets and seven positions to select single or mixed outlets) on single flange.  
Handle steps of the diverter :  
1st step to run water from outlet 1  
2nd step to run water from outlet 2  
3rd step to run water from outlet 3  
4th step to run water from outlet 1  
5th step to run water from outlets 1 + 2  
6th step to run water from outlets 1 + 2 + 3  
7th step to run water from outlets 2 + 3

**N 94 C**  
Come N 95 C, con deviatore a quattro posizioni.  
Same as N 95 C, with 4 positions diverter.



## Docce Shower Mixers



**N 31**  
Miscelatore monocomando esterno per doccia.  
Wall mounted single-lever shower mixer.



**N 39**  
Miscelatore monocomando esterno per doccia, con doccia duplex.  
Wall mounted single-lever shower mixer, with duplex shower.

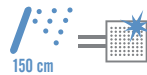

**N 35**  
Gruppo doccia a muro, con deviatore integrato ed attacco alto per colonna da 3/4.  
Wall mounted shower mixer, with integrated diverter and 3/4 upper connection.



**N 35 R**  
Gruppo doccia a muro minimale, con deviatore integrato ed attacco alto per colonna da 3/4.  
Minimal wall mounted shower mixer, with integrated diverter and 3/4 upper connection.

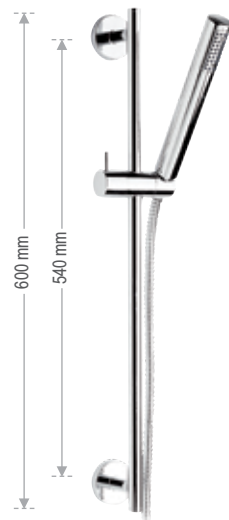

**317M 317DM**  
Saliscendi minimale con doccetta anticalcare.  
Minimal sliding rail set with anti-limestone handshower.

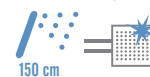

## Colonne doccia Freestanding - Colonne Doccia per Piscina

### Freestanding Shower Columns - Swimming pool Showers Columns



#### 331 N1

Colonna saliscendi free-standing in ottone cromato con attacco da pavimento per doccia, spa, piscina etc, forma minimale rotonda, con comando monoacqua, deviatore, doccetta in ottone cromato e flessibile doccia cm 200, soffione anticalcare in ottone cromato Ø cm 30.

Free-standing chrome plated brass column with single water control for shower, spa, swimming pools, floor mounted, round minimal shape, with diverter and sliding bar, with c.p. brass handshower with flexible cm 200 and c.p. brass anti-limestone shower head Ø 30 cm.



#### 331 N51

Colonna free-standing in ottone cromato con attacco da pavimento per doccia, spa, piscina etc, forma minimale rotonda, con comando monoacqua e soffione anticalcare in ottone cromato Ø cm 30.

Free-standing chrome plated brass column with single water control for shower, spa, swimming pools, floor mounted, round minimal shape, with c.p. brass anti-limestone shower head Ø 30 cm.



#### 331 N2

Colonna con miscelatore acqua calda-fredda saliscendi free-standing con attacco da pavimento, tutta in ottone cromato per doccia, spa, piscina etc, forma minimale rotonda, con deviatore, doccetta in ottone cromato e flessibile doccia cm 200, soffione anticalcare in ottone cromato Ø cm 30.

Free-standing chrome plated brass column with single lever mixer hot/cold water control for shower, spa, swimming pools, floor mounted, round minimal shape, with diverter and sliding bar, with c.p. brass handshower with flexible cm 200 and c.p. brass anti-limestone shower head Ø 30 cm.



#### 331 N52

Colonna free-standing con miscelatore acqua calda-fredda, con attacco da pavimento tutta in ottone cromato per doccia, spa, piscina etc, forma minimale rotonda con soffione anticalcare in ottone cromato Ø cm 30.

Free-standing chrome plated brass column with single lever mixer hot/cold water control for shower, spa, swimming pools, floor mounted, round minimal shape, with c.p. brass anti-limestone shower head Ø 30 cm.



## Colonne doccia

### Shower columns

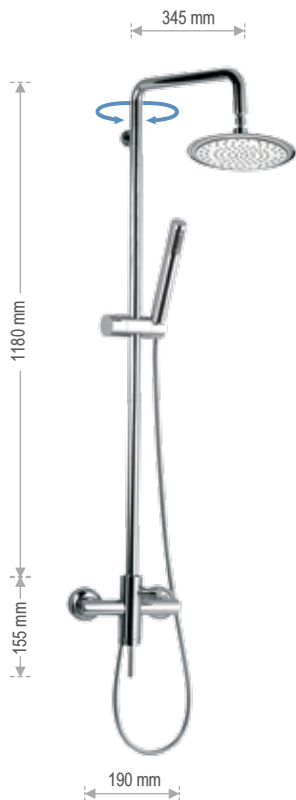

#### N 37

Miscelatore esterno doccia con deviatore integrato e colonna girevole deluxe saliscendi, completa di soffione in abs anticalcare Ø 24 cm, doccetta in Abs cromato e flessibile in ottone.

External shower single lever mixer with incorporated diverter, with swivable deluxe sliding column, complete with anti-limestone abs showerhead Ø 24 cm, Abs minimal handshower and brass flexible hose.



#### N 37 XL

Miscelatore esterno doccia con deviatore integrato e colonna girevole deluxe saliscendi, completa di soffione XL in ottone cromato Ø 35 cm ultrapiatto in ottone anticalcare, doccetta in Abs cromato e flessibile in ottone.

External shower single lever mixer with incorporated diverter, with swivable deluxe sliding column, complete with anti-limestone XL chrome plated showerhead Ø 35 cm, Abs minimal handshower and brass flexible hose.



#### N 37 R

Miscelatore esterno doccia con deviatore integrato e colonna deluxe saliscendi, completa di soffione anticalcare 359MM20 Ø 20 cm, doccetta in Abs cromato e flessibile in ottone.

External shower single lever mixer with incorporated diverter, with swivable deluxe sliding column, complete with anti-limestone showerhead Ø 20 cm, Abs minimal handshower and brass flexible hose.







**N 37 B**

Miscelatore esterno doccia con deviatore integrato e colonna minimal saliscendi girevole, completa di soffionetocalcare in Abs cromato 356MD20 Ø 20 cm e doccetta anticalcare in Abs cromato e flessibile in ottone.

External shower single lever mixer with incorporated diverter, with swivable deluxe sliding column, complete with 356MD20 Abs anti-limestone showerhead Ø 20 cm and Abs minimal handshower and brass flexible hose.



**N 37 B XL**

Miscelatore esterno doccia con deviatore integrato e colonna minimal saliscendi girevole, completa di soffione anticalcare in Abs cromato 356MD25 Ø 25 cm e doccetta anticalcare in Abs cromato e flessibile in ottone.

External shower single lever mixer with incorporated diverter, with swivable deluxe sliding column, complete with 356MD25 Abs anti-limestone showerhead Ø 25 cm, Abs minimal handshower and brass flexible hose.



**N 37 RB**

Miscelatore esterno doccia con deviatore integrato e colonna minimal saliscendi girevole, completa di soffionetocalcare in Abs cromato 356MD20 Ø 20 cm e doccetta anticalcare in Abs cromato e flessibile in ottone.

External shower single lever mixer with incorporated diverter, with swivable deluxe sliding column, complete with 356MD20 Abs anti-limestone showerhead Ø 20 cm, cm Abs minimal handshower and brass flexible hose.



## Wellness



### N 09 S01 UFM20

Set doccia composto da:

Art. 357UFM20 348N 30: Soffione doccia ultra piatto Ø20 in acciaio INOX lucidato a specchio con braccio in ottone cm 30.

Art. 317M 317MM con 333CN150: Saliscendi minimale con doccetta Minimal completamente in ottone cromato e flessibile conico in ottone cromato.

Art. 309 L: presa acqua tipo rotondo pesante.

Art. N 09 L: Miscelatore incasso con deviatore e piastra lusso.

*Disponibile con soffione da cm Ø25, codice: N 09 S01 UFM25*

*Disponibile con soffione da cm Ø30, codice: N 09 S01 UFM30*

*Disponibile con soffione da cm Ø40 e braccio da 40 cm, codice: N 09 S01 UFM40*

Shower set composed by:

Art 357UFM20 348N 30: Ultra slim stainless steel mirror polished shower head Ø20 with arm in brass cm 30.

Art 317M 317MM with 333CN150: Minimal sliding bar with minimal handshower, completely in c.p. brass and with shower flexible hose in brass cm 150.

Art. 309 L: C.p. brass wall connector, round heavy type

Art. N 09 L: Built-in mixer with diverter and deluxe flange.

*Available with head shower cm Ø25, code: N 09 S01 UFM25*

*Available with head shower cm Ø30, code: N 09 S01 UFM30*

*Available with head shower cm Ø40 and arm 40 cm, code: N 09 S01 UFM40*



### N 937 S02 UFM20

Set doccia composto da:

Art. 357UFM20 348N 30: Soffione doccia ultra piatto Ø20 in acciaio INOX lucidato a specchio con braccio in ottone cm 30.

Art. 317M 317MM con 333CN150: Saliscendi minimale con doccetta Minimal completamente in ottone cromato e flessibile conico in ottone cromato.

Art. 309 L: presa acqua tipo rotondo pesante.

Art. N 93 7: miscelatore monocomando per doccia con deviatore a tre vie e sette posizioni su unica piastra.

Art. N 34 JET: 6 getti minimali anticalcare in ottone cromato.

*Disponibile con soffione da cm Ø25, codice: N 937 S02 UFM25*

*Disponibile con soffione da cm Ø30, codice: N 937 S02 UFM30*

*Disponibile con soffione da cm Ø40 e braccio da 40 cm, codice: N 937 S02 UFM40*

Shower set composed by:

Art 357UFM20 348N 30: Ultra slim stainless steel mirror polished shower head Ø20 with arm in brass cm 30.

Art 317M 317MM with 333CN150: Minimal sliding bar with minimal handshower, completely in c.p. brass and with shower flexible hose in brass cm 150.

Art. 309 L: C.p. brass wall connector, round heavy type

Art. N 93 7: single lever built-in shower mixer with three ways diverter with seven position on single flange.

Art. N 34 JET: 6 Minimal jets anti-limestone in c.p. brass.

*Available with head shower cm Ø25, code: N 937 S02 UFM25*

*Available with head shower cm Ø30, code: N 937 S02 UFM30*

*Available with head shower cm Ø40 and arm 40 cm, code: N 937 S02 UFM40*



### N 09 S02 UFM20

Set doccia composto da:

Art. 357UFM20 348N 30: Soffione doccia ultra piatto Ø20 in acciaio INOX lucidato a specchio con braccio in ottone cm 30.

Art. 337M 317MM con 333CN150: Doccia duplex Minimal completamente in ottone cromato con supporto presa acqua e flessibile conico in ottone cromato cm 150.

Art. N 09 L: Miscelatore incasso con deviatore e piastra lusso.

*Disponibile con soffione da cm Ø25, codice: N 09 S02 UFM25*

*Disponibile con soffione da cm Ø30, codice: N 09 S02 UFM30*

*Disponibile con soffione da cm Ø40 e braccio da 40 cm, codice: N 09 S02 UFM40*

Shower set composed by:

Art 357UFM20 348N 30: Ultra slim stainless steel mirror polished shower head Ø20 with arm in brass cm 30.

Art. 337M 317MM with 333CN150: Duplex water punch with Minimal handshower completely in c.p. brass and shower flexible hose in brass cm 150.

Art. N 09 L: Built-in mixer with diverter and deluxe flange.

*Available with head shower cm Ø25, code: N 09 S02 UFM25*

*Available with head shower cm Ø30, code: N 09 S02 UFM30*

*Available with head shower cm Ø40 and arm 40 cm, code: N 09 S02 UFM40*



### N 937 S01 UFM20

Set doccia composto da:

Art. 357UFM20 348N 30: Soffione doccia ultra piatto Ø20 in acciaio INOX lucidato a specchio con braccio in ottone cm 30.

Art. 337M 317MM con 333CN150: Doccia duplex Minimal completamente in ottone cromato con supporto presa acqua e flessibile conico in ottone cromato cm 150.

Art. N 93 7: miscelatore monocomando per doccia con deviatore a tre vie e sette posizioni su unica piastra.

Art. N 34 JET: 6 getti minimali anticalcare in ottone cromato.

*Disponibile con soffione da cm Ø25, codice: N 937 S01 UFM25*

*Disponibile con soffione da cm Ø30, codice: N 937 S01 UFM30*

*Disponibile con soffione da cm Ø40 e braccio da 40 cm, codice: N 937 S01 UFM40*

Shower set composed by:

Art 357UFM20 348N 30: Ultra slim stainless steel mirror polished shower head Ø20 with arm in brass cm 30.

Art. 337M 317MM with 333CN150: Minimal handshower completely in c.p. brass with shower flexible hose in brass cm 150 and duplex shower holder

Art. N 93 7: single lever built-in shower mixer with three ways diverter with seven position on single flange.

Art. N 34 JET: 6 Minimal jets anti-limestone in c.p. brass.

*Available with head shower cm Ø25, code: N 937 S01 UFM25*

*Available with head shower cm Ø30, code: N 937 S01 UFM30*

*Available with head shower cm Ø40 and arm 40 cm, code: N 937 S01 UFM40*





### N 94 S01 UFMCA

Set doccia composto da:

Art. 350UFMCA: Soffione doccia ultrapiatto 50x25 cm, a parete in acciaio INOX lucidato a specchio, 2 getti, normale o cascata.

Art. 317M 317MM con 333CN150: Saliscendi minimale con doccetta Minimal completamente in ottone cromato e flessibile conico in ottone cromato.

Art. 309 L: presa acqua tipo rotondo pesante.

Art. N 94: miscelatore monocomando per doccia con deviatore a 4 posizioni su piastra unica.

Art. N 34 JET: 6 getti minimali anticalcare in ottone cromato.

Disponibile con soffione 350UFM senza cascata e miscelatore incasso con deviatore N93, codice: N 937 S01 UFM

Shower set composed by:

Art. 350UFMCA: Ultra slim stainless steel mirror polished wall shower head, 2 jets, normal and waterfall, 50x25 cm.

Art. 317M 317MM with 333CN150: Minimal sliding bar with minimal handshower, completely in c.p. brass and with shower flexible hose in brass cm 150.

Art. 309 L: C.p. brass wall connector, round heavy type

Art. N 94: single lever built-in shower mixer with four ways diverter with 4 positions diverter on single flange.

Art. N 34 JET: 6 Minimal jets anti-limestone in c.p. brass.

Available with head shower 350 UFM without waterfall jet and built-in mixer with diverter N93, code: N 937 S01 UFM



150 cm



### N 937 S01 UFMCA

Set doccia composto da:

Art. 350UFMCA: Soffione doccia ultrapiatto 50x25 cm, a parete in acciaio INOX lucidato a specchio, 2 getti, normale o cascata.

Art. 317M 317MM con 333CN150: Saliscendi minimale con doccetta Minimal completamente in ottone cromato e flessibile conico in ottone cromato.

Art. 309 L: presa acqua tipo rotondo pesante.

Art. N 93 7: miscelatore monocomando per doccia con deviatore a tre vie e sette posizioni su unica piastra.

Disponibile con soffione 350UFM senza cascata e miscelatore incasso con deviatore N09L, codice: N 09 S01 UFM

Shower set composed by:

Art. 350UFMCA: Ultra slim stainless steel mirror polished wall shower head, 2 jets, normal and waterfall, 50x25 cm.

Art. 317M 317MM with 333CN150: Minimal sliding bar with minimal handshower, completely in c.p. brass and with shower flexible hose in brass cm 150.

Art. 309 L: C.p. brass wall connector, round heavy type

Art. N 93 7: single lever built-in shower mixer with three ways diverter with seven position on single flange.

Available with head shower 350 UFM without waterfall jet and built-in mixer with diverter N09L, code: N 09 S01 UFM



150 cm



### N 94 S02 UFMCA

Set doccia composto da:

Art. 350UFMCA: Soffione doccia ultrapiatto 50x25 cm, a parete in acciaio INOX lucidato a specchio, 2 getti, normale o cascata.

Art. 337M 317MM con 333CN150: Doccia duplex Minimal completamente in ottone cromato con supporto presa acqua e flessibile conico in ottone cromato cm 150.

Art. N 94: miscelatore monocomando per doccia con deviatore a 4 posizioni su piastra unica.

Art. N 34 JET: 6 getti minimali anticalcare in ottone cromato.

Disponibile con soffione 350UFM senza cascata e miscelatore incasso con deviatore N93, codice: N 937 S02 UFM

Shower set composed by:

Art. 350UFMCA: Ultra slim stainless steel mirror polished wall shower head, 2 jets, normal and waterfall, 50x25 cm.

Art. 339N 317MM with 333CN150: Minimal handshower completely in c.p. brass with shower flexible hose in brass cm 150 and duplex shower holder

Art. N 94: single lever built-in shower mixer with four ways diverter with 4 positions diverter on single flange.

Art. N 34 JET: 6 Minimal jets anti-limestone in c.p. brass.

Available with head shower 350 UFM without waterfall jet and built-in mixer with diverter N93, code: N 937 S02 UFM



150 cm



### N 937 S02 UFMCA

Set doccia composto da:

Art. 350UFMCA: Soffione doccia ultrapiatto 50x25 cm, a parete in acciaio INOX lucidato a specchio, 2 getti, normale o cascata.

Art. 337M 317MM con 333CN150: Doccia duplex Minimal completamente in ottone cromato con supporto presa acqua e flessibile conico in ottone cromato cm 150.

Art. N 93 7: miscelatore monocomando per doccia con deviatore a tre vie e sette posizioni su unica piastra.

Disponibile con soffione 350UFM senza cascata e miscelatore incasso con deviatore N09L, codice: N 09 S02 UFM

Shower set composed by:

Art. 350UFMCA: Ultra slim stainless steel mirror polished wall shower head, 2 jets, normal and waterfall, 50x25 cm.

Art. 339N 317MM with 333CN150: Minimal handshower completely in c.p. brass with shower flexible hose in brass cm 150 and duplex shower holder

Art. N 93 7: single lever built-in shower mixer with three ways diverter with seven position on single flange.

Available with head shower 350 UFM without waterfall jet and built-in mixer with diverter N09L, code: N 09 S02 UFM



150 cm

## Wellness



### N 09 S01

Set doccia composto da:

Art. 356LU 348N 30: Soffione minimale anticalcare con braccio in ottone cm 30.

Art. 317M 317DM con 333CN 150: Saliscendi minimale con doccetta anticalcare e flessibile conico in ottone cromato.

Art. 309 L: presa acqua tipo rotondo pesante.

Art. N 09 L: Miscelatore incasso con deviatore e piastra lusso.

Shower set composed by:

Art 356LU 348N 30: Minimal anti-limestone showerhead with arm in brass cm 30.

Art 317M 317DM with 333CN 150: Minimal sliding bar with anti-limestone handshower and with shower flexible hose in brass cm 150.

Art. 309 L: C.p. brass wall connector, round heavy type

Art. N 09 L: Built-in mixer with diverter and deluxe flange.

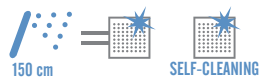

### N 09 S02

Set doccia composto da:

Art. 356LU 348N 30: Soffione minimale anticalcare con braccio in ottone cm 30.

Art. 337M 317DM con 333CN 150: Doccia duplex minimale anticalcare con supporto presa acqua e flessibile conico in ottone cromato cm 150.

Art. N 09 L: Miscelatore incasso con deviatore e piastra lusso.

Shower set composed by:

Art. 356LU 348N 30: Minimal anti-limestone showerhead with arm in brass cm 30.

Art. 337M 317DM with 333CN 150: Duplex water punch with minimal anti-limestone handshower with shower flexible hose in brass cm 150.

Art. N 09 L: Built-in mixer with diverter and deluxe flange.



### N 09 S03

Set doccia composto da:

Art. 356LU 348N 30: Soffione minimale anticalcare con braccio in ottone cm 30.

Art. 339N 317DM con 333CN 150: Doccia duplex minimale anticalcare con supporto duplex e flessibile conico in ottone cromato cm 150.

Art. 91 MD: Bocca incasso Minimal con deviatore integrato.

Art. N 09 L: Miscelatore incasso con deviatore e piastra lusso

Shower set composed by:

Art 356LU 348N 30: Minimal anti-limestone showerhead with arm in brass cm 30

Art. 339N 317DM with 333CN 150: Minimal anti-limestone handshower with shower flexible hose in brass cm 150 and duplex shower holder

Art. 91 MD: Minimal built-in spout with diverter.

Art. N 09 L: Built-in mixer with diverter with deluxe flange.



### N 93 7 S01

Set doccia composto da:

Art. 359MM30 348N 30: soffione minimale anticalcare in ottone Ø 30, con braccio in ottone cm 30.

Art. 337M 321HG con 333CN 150: Doccia minimale a 3 funzioni, con getti in silicone, supporto doccia duplex in ottone cromato con presa acqua e flessibile conico in ottone cromato cm 150.

Art. N34JET: 6 getti minimali anticalcare in ottone cromato.

Art. N 93 7: miscelatore monocomando per doccia con deviatore a tre vie e sette posizioni su unica piastra.

Shower set composed by:

Art. 359MM30 348N 30: Minimal anti-limestone shower head in c.p. brass Ø 30 cm with arm in brass cm 30.

Art. 337M 321HG with 333CN 150: water-punch in c.p. brass with duplex holder, minimal handshower, 3 functions, with silicon jets, with shower flexible hose in brass cm 150.

Art. N 34 JET: 6 Minimal jets anti-limestone in c.p. brass

Art. N 93 7: single lever built-in shower mixer with three ways diverter with seven position on single flange.



### N 93 7 S02

Set doccia composto da:

Art. 359MM30 348N 30: soffione minimale anticalcare in ottone Ø 30, con braccio in ottone cm 30.

Art. 317G 321HG con 333CN 150: Saliscendi in ottone cromato e doccetta minimale a 3 funzioni con getti in silicone e flessibile conico in ottone cromato cm 150.

Art. 309 L: presa acqua tipo rotondo pesante.

Art. N 34 JET: 6 getti minimali anticalcare in ottone cromato.

Art. N 93 7: miscelatore monocomando per doccia con deviatore a tre vie e sette posizioni su unica piastra.

Shower set composed by:

Art. 359MM30 348N 30: Minimal anti-limestone shower head in c.p. brass Ø 30 cm with arm in brass cm 30.

Art 317G 321HG with 333CN 150: Minimal c.p. brass sliding bar with handshower 3 functions with silicon jets and with flexible hose in brass cm 150.

Art. 309 L: C.p. brass wall connector, round heavy type

Art. N 34 JET: 6 Minimal jets anti-limestone in c.p. brass.

Art. N 93 7: single lever built-in shower mixer with three ways diverter with seven position on single flange.





### N 09 S11

Set doccia composto da:

Art. 330U 356LU 317DM 330RA con 333CN 150: Colonna doccia deluxe girevole con deviatore e saliscendi, completa di soffione doccia cromato anticalcare, doccetta minimale, flessibile doccia e supporto presa acqua per colonna.

Art. N 09 L: Miscelatore monocomando incasso con deviatore e piastra lusso.

Art. 91M: Bocca incasso Minimale.

Shower set composed by:

Art. 330U 356LU 317DM 330RA with 333CN 150: Swivable deluxe shower column with diverter and sliding rail, with anti-limestone showerhead and handshower, flexible in c.p. brass cm 150 and water punch-support for columns.

Art. N 09 L: Single-lever built-in shower mixer with diverter and deluxe flange.

Art. 91M: Minimal built-in spout.

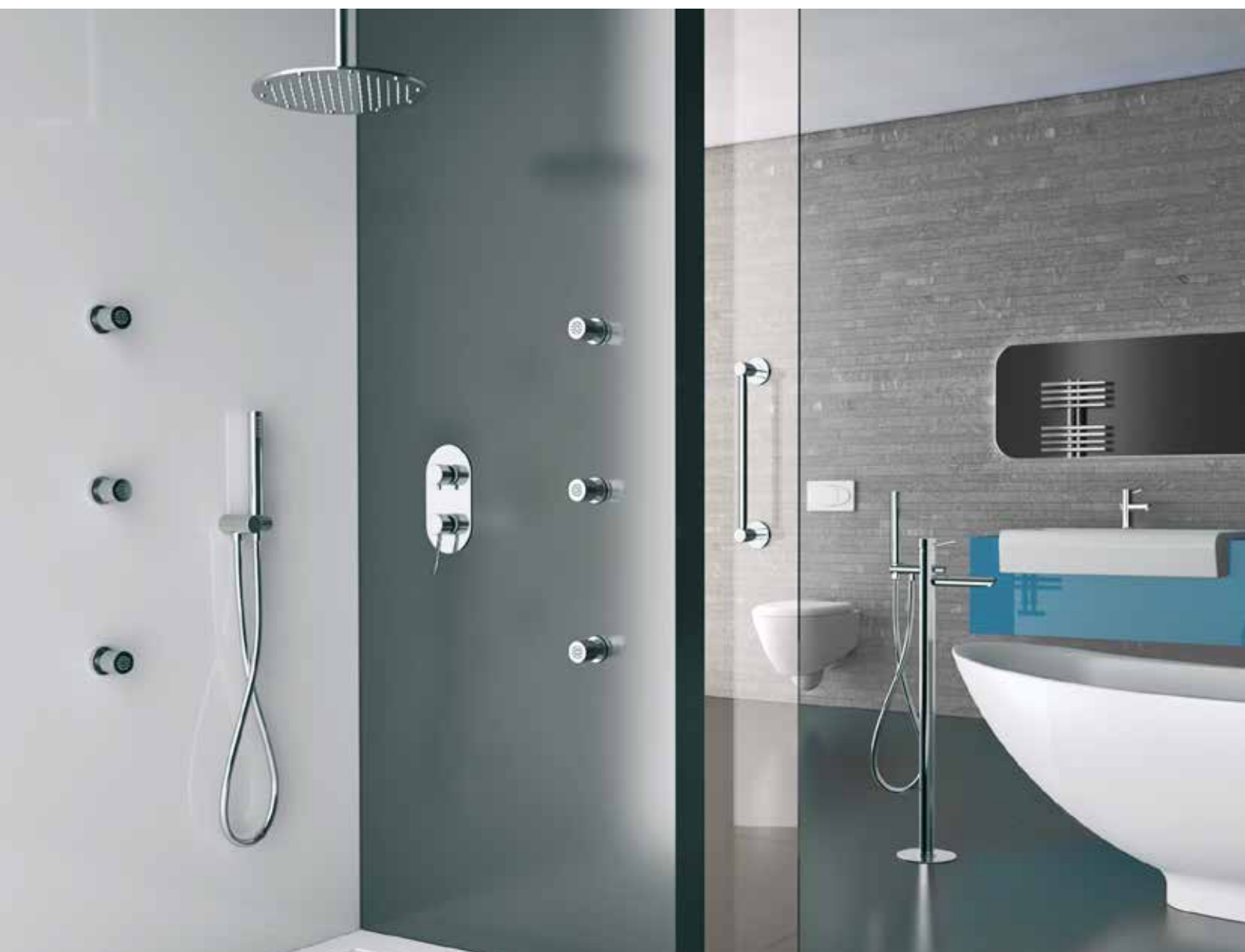

# MINIMAL

CUCINA  
KITCHEN



## Cucina Kitchen



**N 40**  
Miscelatore monocomando per lavello.  
Single-lever one-hole sink mixer.



**N 40 L**  
Miscelatore monocomando per lavello.  
Single-lever one-hole sink mixer.



**N 47**  
Miscelatore monocomando per lavello, con bocca estraibile.  
Single-lever one-hole sink mixer, with pull-out spray jet shower.



**N 41**  
Miscelatore monocomando per lavello a muro, con bocca girevole.  
Single-lever wall mounted sink mixer, with movable spout.



**N 48 319 MO**  
Miscelatore monocomando bordo lavello serie Minimal con deviatore, bocca minimale e doccetta cromata minimale a 4 funzioni con getti in silicone, idromassaggio ed anticalcare.

Single lever deck sink mixer serie Minimal with diverter, with C.p. minimal handshower 4 functions hydromassage, anti-limestone with silicone jets.



**N 48 332 EU**  
Miscelatore monocomando bordo lavello serie Minimal con deviatore, bocca minimale e doccetta a pulsante minimale in Abs cromata con impugnatura liscia 1/2".

Single lever deck sink mixer serie Minimal with diverter, with C.p. Abs minimal shut-off, with plain handgrip 1/2".



## Cucina Acqua Depurata Purified Water Kitchen



**N 40 DW**  
Miscelatore lavello Minimale a tre vie di ingresso con bocca girevole, con selezione acqua potabile tramite la leva, con 2 aeratori in uscita.

Three ways inlet minimal single lever sink mixer, with movable spout, with selection for drinking water directly from the lever, with 2 exit aerators.





Remer Rubinetterie S.p.A.  
Via Leonardo da Vinci, 83  
20062 Cassano d'Adda (MI) Italy  
Tel. +39 0363 364 211  
E-Mail: [info@remer.eu](mailto:info@remer.eu)  
[www.remer.eu](http://www.remer.eu)

Ufficio Commerciale Italia:  
Tel. 0363 364 333  
Fax 0363 63 575

Export Commercial Department:  
Tel. +39 0363 364 364  
Fax +39 0363 364 300